

Architectural Door Accessories

McKinney 40A Concealed Hinge 3D Adjustable

The global leader in
door opening solutions

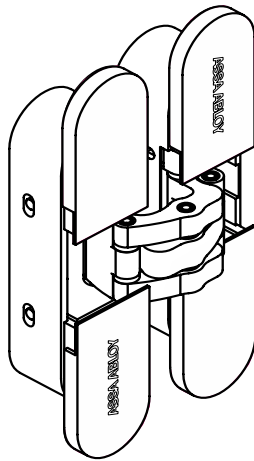

Hinge Arrangement

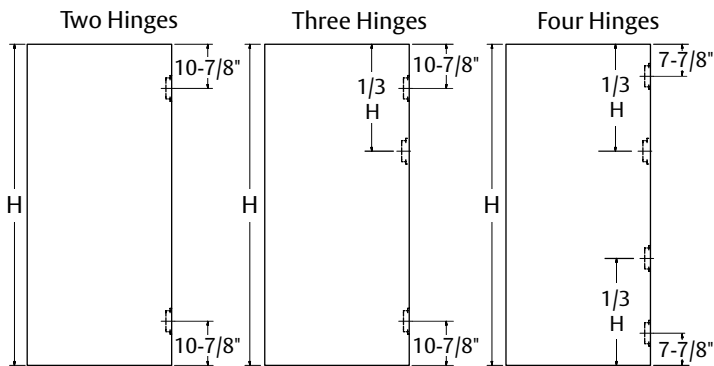

"H" Min. = 80"

Load Capacity

See chart for minimum number of hinges required based on correct adjustment (all hinges carrying load), door width and door weight.

Door height minimum is 80".

Door thickness minimum is 1-1/4".

Note: Hinge spacing does not effect load capacity. The first door should always be checked before preparing more doors, if any.

Hinges	Door Width			
	32"	36"	42"	48"
2	92 lb	88 lb	72 lb	66 lb
3	105 lb	99 lb	81 lb	74 lb
4	116 lb	110 lb	86 lb	79 lb

Hinge Dimensions (millimeters)

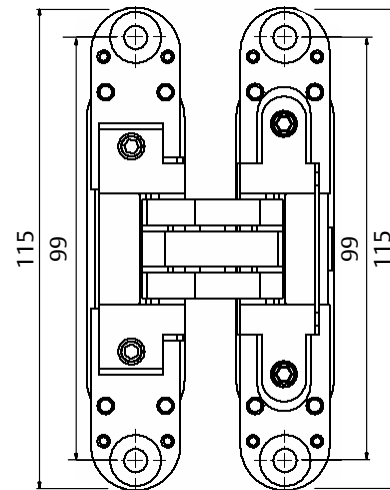
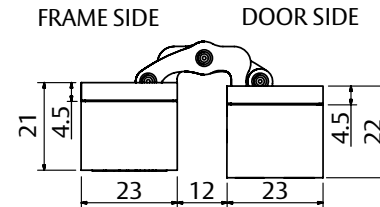

Milling Dimensions (millimeters)

Frame Side

Door Side

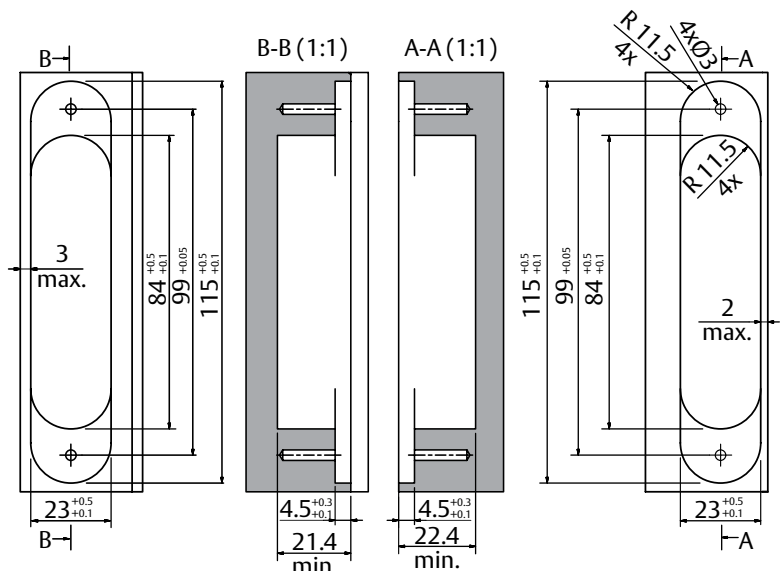

Hinge Position In Relation to Required Door and Frame Dimensions (millimeter)

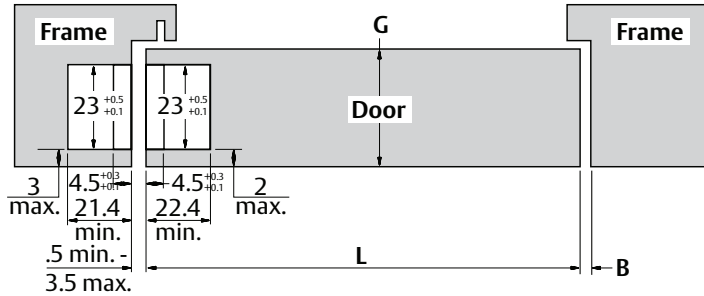

	"G" Thickness of Door	"L" Width of Door			
		32"	36"	42"	48"
Min Slot "B" (mm)	1-3/8"	2	2	2	2
	1-3/4"	3	3	3	3
	2"	4	4	4	4
	2-1/4"	5	5	4	4

Installation

1. Insert each hinge section marked "door" into door sockets created in milling. Hinges should be flush against door edge surface.
2. Secure hinge sections with two (2) 35mm PHWS screws provided in screw packet.
3. Set door on frame by inserting each loose hinge section into socket created in milling.
4. Secure each hinge with two (2) 35mm PHWS screws provided in screw packet.
5. Make adjustments.
6. Insert front hinge covers to hide screws. Note: Removal of covers should be done carefully.

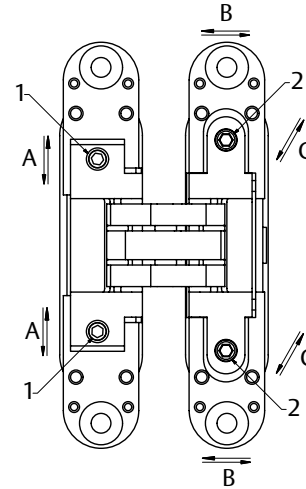

Adjustment

Adjustments to hinge are made with a 3mm Allen wrench. All hinges should carry load for proper installation.

- A. Vertical Adjustment (range $\pm 1.5\text{mm}$):**
Make sure that top adjustment screw (1) is even with front surface of hinge. If it is not, unscrew it for this position. Adjust hinge by turning bottom adjustment screw (1). After adjusted, tighten top adjustment screw (1).
- B. Depth Adjustment (Range $\pm 1\text{mm}$)**
- C. Horizontal Adjustment (Range $\pm 1.5\text{mm}$)**
Depth adjustment and horizontal adjustment take place simultaneously. Adjust hinge by alternately turning both screws (2).

