

# Key in Knob & Key in Lever



We take the worry out of  
protecting what's valuable to you.  
Lockwood: *no worries*<sup>®</sup>

**25YEAR** MECHANICAL  
WARRANTY

**LOCKWOOD**

**ASSA ABLOY**

[www.lockweb.com.au](http://www.lockweb.com.au)

# Contents



## 530 Series

Key in Knob & Key in Lever  
Door Furniture Locksets

page 3



## 930/950 Series

Key in Lever  
Door Furniture Locksets

page 6



## Symmetry® Series

Key in Knob & Key in Lever  
Door Furniture Locksets

page 10



## Enable® Series

Key in Lever Locksets

page 16

# 530 Series Key in Knob Locksets



The 530 series is designed as a non-handed, easy-to-install lockset. This high quality range is suitable for residential and semi-commercial applications including office partitioning.

## Features and Specifications

### Cylinder

- 5 pin tumbler mechanism
- Brass cylinder and brass barrel

### Keying

#### Standard Keying

- Supplied individually keyed with two keys per lock
- 78,000 key combinations
- Key blank KB2015P

### Restricted Special Keying

Lockwood locks can be keyed to a number of controlled and/or specially keyed systems. These range from legally protected keys to protect against unauthorised duplication, which can also include specially designed key systems such as master key systems, which allow for different levels of mechanical access control.

Please refer to Lockwood Keying Catalogue or contact your local sales office or customer service for specific information.

## Product Details

<b>Backset</b>	60mm standard backset. 70mm and 127mm latches available separately
<b>Door Thickness</b>	32 to 48mm (all functions except 534 which suits doors 32 to 45mm).
<b>Finishes</b>	Satin Chrome Brushed (SC)
<b>Handing</b>	Non-handed lockset
<b>Latch</b>	13mm projection brass bolt
<b>Materials</b>	High purity zinc alloy

## Standards and Compliance



Successfully tested to 2 hours on fire door assemblies in accordance with Australian Standard AS1905.1:2005 Fire Resistant Doorsets.

# 530 Series Key in Knob Locksets

530

**Part Number** 530

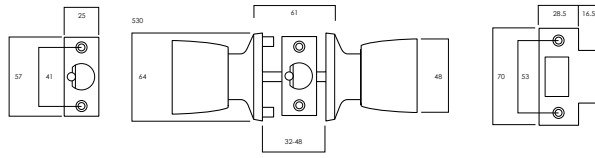

## 529 Exterior Escape Deadlatch

**Part Number** 529SC

**Outside** Opened by knob when unlocked. Key locks or unlocks exterior knob but does not retract bolt

**Inside** Opened by knob at all times. Turnbutton locks or unlocks exterior knob

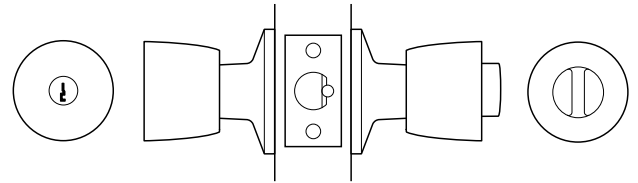

## 530 Entrance Set

**Part Number** 530SC

**Outside** Opened by knob when unlocked. Key locks or unlocks both knobs but does not retract bolt

**Inside** Opened by knob when unlocked. Turnbutton locks both knobs

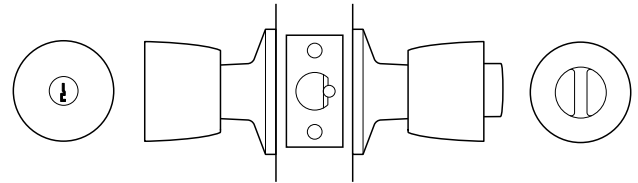

## 531 Passage

**Part Number** 531SC

**Outside** Opened by knob at all times

**Inside** Opened by knob at all times

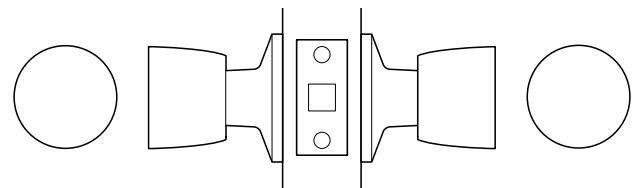

## 532 Privacy Set

**Part Number** 532SC

**Outside** Opened by knob when unlocked. Coin or screwdriver in emergency button unlocks both knobs but does not retract bolt

**Inside** Opened by knob when unlocked. Turnbutton locks both knobs

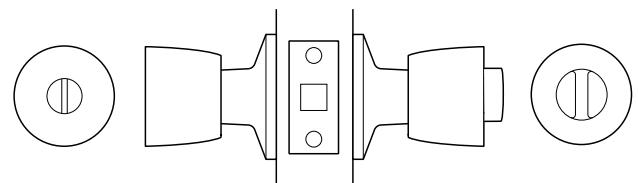

# 530 Series Key in Knob Locksets

## 534 Glass Door Set

**Part Number** 534SC

**Outside** Opened by knob when unlocked. Key locks or unlocks both knobs but does not retract bolt

**Inside** Opened by knob when unlocked. Key locks or unlocks both knobs but does not retract bolt

**Note:** For extra security against removal of the interior handle and rose, one-way mounting screws are supplied.

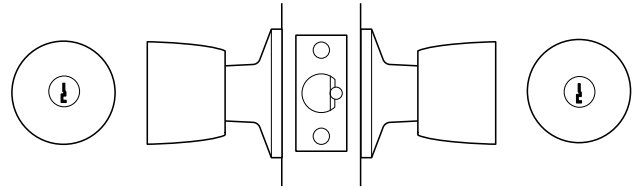

## 536 Escape Set

**Part Number** 536SC

**Outside** Opened by knob when unlocked. Key locks or unlocks exterior knob but does not retract bolt.

**Inside** Opened by knob at all times

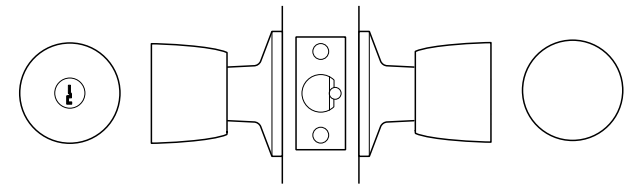

## 538 Storeroom Escape Set

**Part Number** 538SC

**Outside** Opened by key only. Knob is always rigid

**Inside** Opened by knob at all times

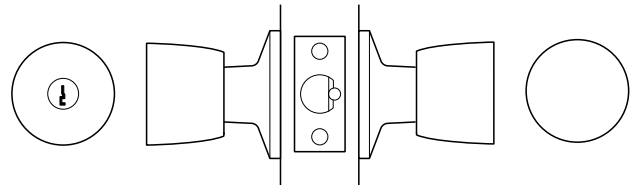

# 930 & 950 Series Key in Lever Locksets



The Lockwood Key in Lever Locksets feature a choice of two levers - the 930 series and the 950 series. These locksets are produced from high purity zinc alloy and are available in a comprehensive range of functions.

## Features and Specifications

### Cylinder

- 5 pin tumbler mechanism
- Brass cylinder and brass barrel

### Keying

#### Standard Keying

- Supplied individually keyed with two keys per lock
- 78,000 key combinations
- Key blank KB2015P

### Restricted Special Keying

Lockwood locks can be keyed to a number of controlled and/or specially keyed systems. These range from legally protected keys to protect against unauthorised duplication, which can also include specially designed key systems such as master key systems, which allow for different levels of mechanical access control.

## Product Details

<b>Backset</b>	70mm standard backset. 60mm and 127mm latches available separately
<b>Door Thickness</b>	32 to 45mm (all functions except 934 and 954 which suit doors 35 to 41mm).
<b>Finishes</b>	Satin Chrome Brushed (SC)
<b>Handing</b>	Field adjustable handing
<b>Latch</b>	13mm projection
<b>Materials</b>	High purity zinc alloy. A rose cover is supplied to conceal internal fixing screws.

## Standards and Compliance



Successfully tested to 2 hours on fire door assemblies in accordance with Australian Standard AS1905.1:2005 Fire Resistant Doorsets.

# 930 & 950 Series Key in Lever Locksets

930

Part Number 930

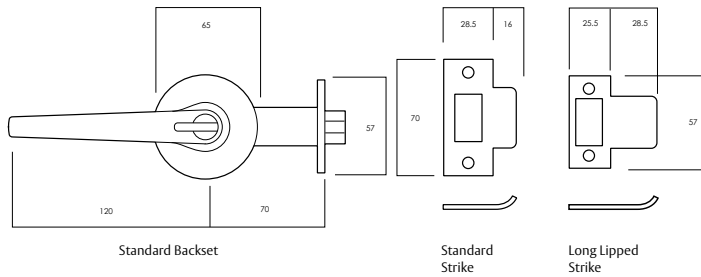
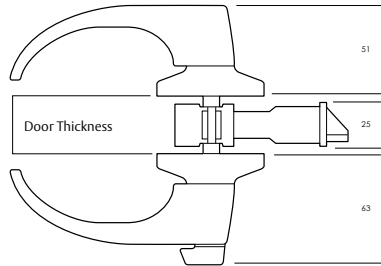

950

Part Number 950

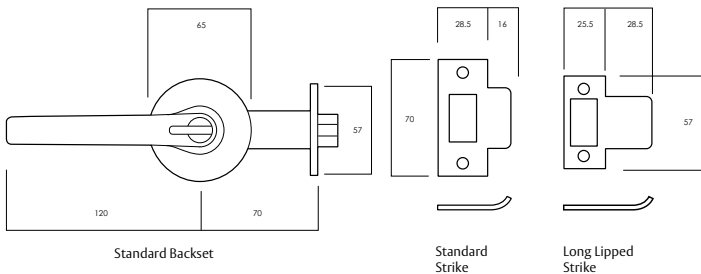
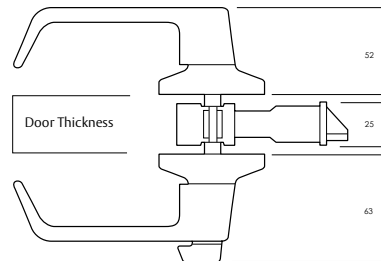

# 930 & 950 Series Key in Lever Locksets

## 929 and 949 Exterior Escape Deadlatch

**Part Number** 929SC, 949SC

**Outside** Opened by handle when unlocked. Key locks or unlocks exterior handle but does not retract the bolt

**Inside** Opened by handle at all times. Turnknob locks or unlocks exterior handle.

**Note:** 930 Series levers shown.

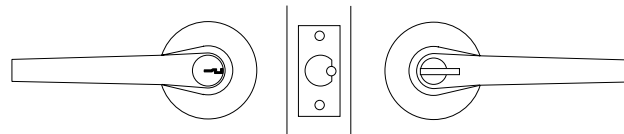

## 930 and 950 Exterior Deadlatch

**Part Number** 930SC, 950SC

**Outside** Opened by handle when unlocked. Key locks or unlocks exterior handle but does not retract the bolt

**Inside** Opened by handle when unlocked. Turnknob locks or unlocks both handles

**Note:** 930 Series levers shown.

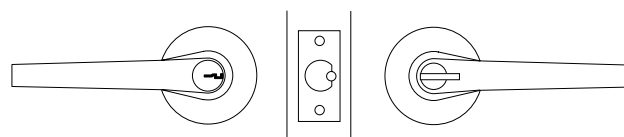

## 931 and 951 Passage Set

**Part Number** 931SC, 951SC

**Outside** Opened by handle at all times

**Inside** Opened by handle at all times

**Note:** 930 Series levers shown.

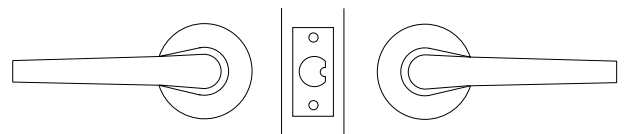

## 932 and 952 Privacy Set

**Part Number** 932SC, 952SC

**Outside** Opened by handle when unlocked. Coin or screwdriver in emergency button unlocks handle but does not retract bolt

**Inside** Opened by handle when unlocked.

**Note:** 930 Series levers shown.

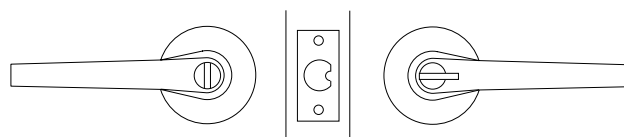



# 930 & 950 Series Key in Lever Locksets

## 934 and 954 Glass Door Deadlatch

**Part Number** 934SC, 954SC

**Outside** Opened by handle when unlocked. Key locks or unlocks both handles but does not retract the bolt.

**Inside** Opened by handle when unlocked. Key locks or unlocks both handles but does not retract the bolt.

**Note:** 930 Series levers shown. For extra security against removal of the interior handle and rose, one-way mounting screws are supplied.

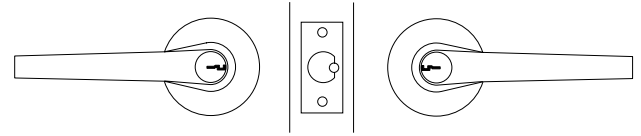

## 936 and 956 Exterior Escape Deadlatch

**Part Number** 936SC, 956SC

**Outside** Opened by handle when unlocked. Key locks or unlocks exterior handle but does not retract the bolt.

**Inside** Opened by handle at all times.

**Note:** 930 Series levers shown.

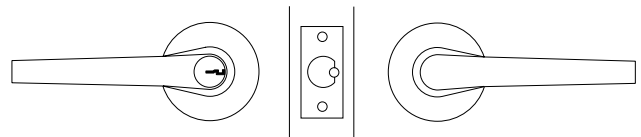

## 938 and 958 Storeroom Escape Deadlatch

**Part Number** 938SC, 958SC

**Outside** Opened only by key. Key retracts bolt. Outside handle is rigid at all times.

**Inside** Opened by handle at all times

**Note:** 930 Series levers shown. For extra security against removal of the interior handle and rose, one-way mounting screws are supplied.

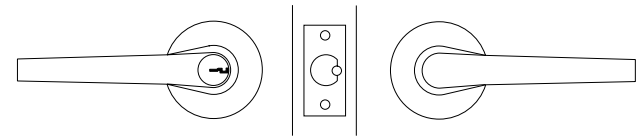

# Symmetry® Key in Knob & Key in Lever



The Symmetry door handle range offers builders, developers, specifiers and interior designers a wide selection of product that can be used in any residential application

The Symmetry series is produced to meet the demanding quality and style requirements of the Australian market.

All products are tested in accordance with the security and durability requirements of the Australian Standards.

Along with the Lockwood 25 year Mechanical Warranty all Symmetry door furniture is supplied with a 5 year finish Guarantee with the exception of the Everbrass finish which has a 25 year finish Guarantee.

## Keying

### Standard Keying

- Supplied individually keyed with three keys per lock
- 78,000 key combinations
- Key blank KB2015P

### Restricted Special Keying

Lockwood locks can be keyed to a number of controlled and/or specially keyed systems. These range from legally protected keys to protect against unauthorised duplication, which can also include specially designed key systems such as master key systems, which allow for different levels of mechanical access control. Please refer to Lockwood Keying Catalogue or contact your local sales office or customer service for specific information.

### Symmetry Everbrass® Guarantee



Lockwood Everbrass® product is coated both on the exterior and interior surfaces with a lifetime anti-tarnish finish. Lockwood warrants that Everbrass® branded product will not corrode, tarnish or discolour for a lifetime when properly installed and subject to no more than fair wear and tear.

### Product Details

<b>Backset</b>	60 to 70mm adjustable latch standard
<b>Cylinder</b>	5 pin Lockwood C4 brass cylinder assembly (6 pin compatible)
<b>Functions</b>	Entrance, privacy, passage and dummy available
<b>Handing</b>	Suitable for left and right handed doors
<b>Installation</b>	Easy to install with detailed mounting instructions
<b>Latch</b>	13mm throw
<b>Strike</b>	D-strike with anti-rattle tab as standard

### Symmetry 5 Year Finish Guarantee



Lockwood guarantees to replace Symmetry product if within five years from the proven date of purchase it tarnishes, discolours or corrodes when properly installed and subject to no more than fair wear and tear.

### 1 ONECYL®

The exclusive one cylinder assembly solution 'OneCyl®' has been designed for the entire Lockwood Symmetry Range, which grants the convenience of cylinder interchangeability.

# Symmetry® Key in Knob & Key in Lever

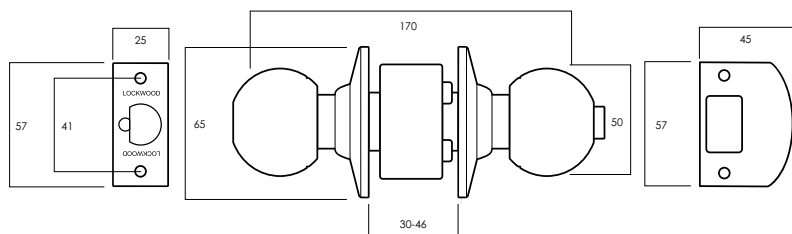

## Symmetry® – Imperial Series

### Part Numbers      Function

7020	Entrance
7021	Passage
7022	Privacy
7025	Dummy

## Standards and Compliance



Lockwood Symmetry® – Imperial Knobset has been successfully tested up to four hours (depending on type of doorset) on fire door assemblies in accordance with Australian standard As 1905.1- 2005, Part 1: Fire Resistant Doorsets.

## Symmetry® – Imperial Knobset

<b>Type</b>	Cylindrical Latch
<b>Materials</b>	<b>Key in Knob:</b> Knob–Stainless Steel and Brass <b>Type:</b> Cylindrical <b>Chassis:</b> Steel <b>Bolt Head:</b> Stainless steel
<b>Fixing</b>	Vertical mounting screw fixing. Fixing concealed with snap-on trim
<b>Door Thickness</b>	32–46mm for timber doors
<b>Finish</b>	Polished Stainless Steel, Satin Stainless Steel
<b>Packaging</b>	Trade Pack only

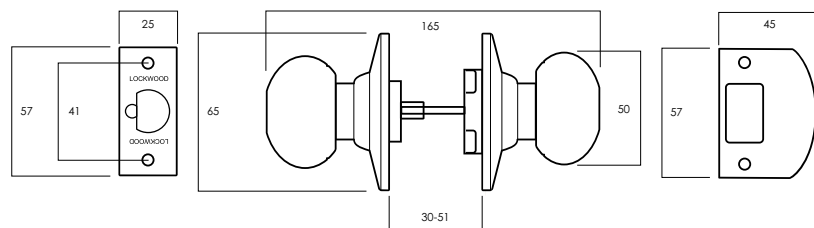

## Symmetry® – Manor Series

### Part Numbers      Function

7010	Entrance
7011	Passage
7012	Privacy
7015	Dummy

## Symmetry® – Manor Knobset

<b>Type</b>	Tubular Latch
<b>Materials</b>	<b>Key in Knob:</b> Knob–Stainless Steel and Brass <b>Chassis:</b> Steel <b>Bolt head:</b> Zinc
<b>Fixing</b>	Horizontal mounting screw fixing
<b>Door Thickness</b>	35–45mm for timber doors
<b>Finish</b>	Everbrass, Polished Stainless Steel, Satin Stainless Steel, Black Chrome Plate
<b>Packaging</b>	Trade Pack and Display Packs available

# Symmetry® Key in Knob & Key in Lever

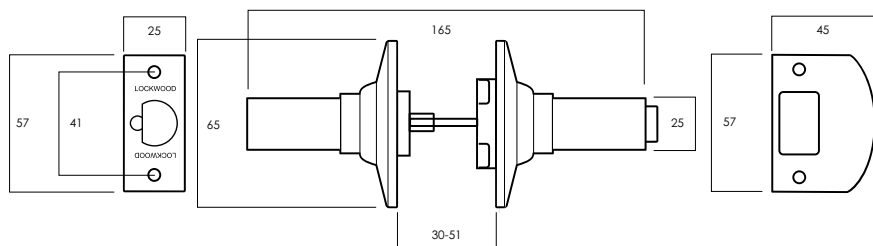

## Symmetry® – Vicinity Series

Part Numbers	Function
7530	Entrance
7531	Passage
7532	Privacy
7535	Dummy

## Symmetry® – Vicinity Leverset

<b>Type</b>	Tubular Latch
<b>Materials</b>	<b>Key in Lever:</b> Zinc Alloy <b>Chassis:</b> Steel <b>Bolt head:</b> Zinc
<b>Fixing</b>	Horizontal mounting screw fixing
<b>Door Thickness</b>	35–45mm for timber doors
<b>Finish</b>	Everbrass, Chrome Plate, Satin Chrome Brushed
<b>Packaging</b>	Trade Pack available. Display packs (entrance only)

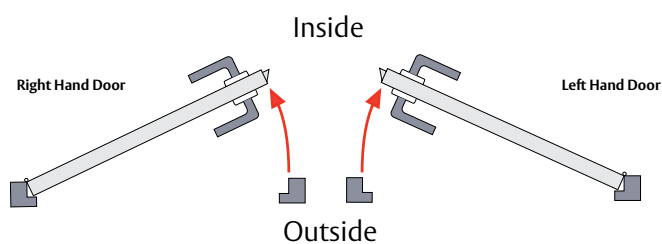

## Symmetry® – District Series

Part Numbers	Function
7540	Entrance
7541	Passage
7542	Privacy
7545 or 7545L	Dummy

## Symmetry® – District Leverset

<b>Type</b>	Tubular Latch
<b>Materials</b>	<b>Key in Knob:</b> Zinc Alloy <b>Chassis:</b> Steel <b>Bolt head:</b> Zinc
<b>Fixing</b>	Horizontal mounting screw fixing
<b>Door Thickness</b>	35–45mm for timber doors
<b>Finish</b>	Everbrass, Chrome Plate, Satin Chrome Brushed
<b>Packaging</b>	Trade Pack only available

# Symmetry® Key in Knob & Key in Lever

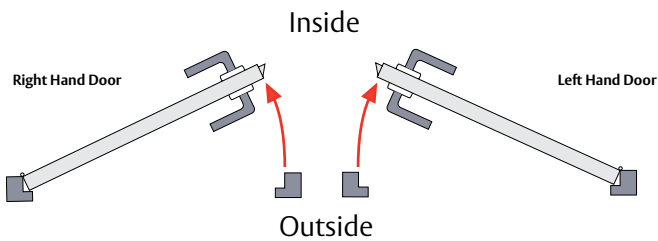

## Symmetry® – Element™ Series

Part Numbers	Function
7550	Entrance
7551	Passage
7552	Privacy
7555	Dummy

## Symmetry® – Element™ Leverset

<b>Type</b>	Tubular Latch
<b>Materials</b>	<b>Key in Lever:</b> Zinc Alloy
	<b>Chassis:</b> Steel
	<b>Bolt head:</b> Zinc
<b>Fixing</b>	Horizontal mounting screw fixing
<b>Door Thickness</b>	35–45mm for timber doors
<b>Finish</b>	Chrome Plate, Satin Chrome Brushed
<b>Packaging</b>	Trade Pack only available

# Symmetry® Series - Accessories

## Single and Double Cylinder Deadbolt

Part Numbers	Function
7106	Single Cylinder
7107	Double Cylinder

Recommended to be used in conjunction with all Symmetry knob and lever styles. Single Cylinder – key operation from outside and a turn knob from the inside. Double Cylinder – key operation from outside and inside.

**Note:** For added security a deadbolt should be fitted in addition to the handle set. Refer to Lockwood Deadbolts Catalogue for range and part number information.



Single Cylinder Deadbolt



Double Cylinder Deadbolt

## Universal Rebate Kit

Part Number	Description
7579	Universal Rebate Kit

The Symmetry series of Key in Knob, Key in Lever and Deadbolt products can be converted for use on rebated double doors with a standard 12 to 13mm rebate by installation with this Universal Rebate Kit.

**Note:** Surface mounted strike box available. A wide selection of Flush Pulls, Latches and Strikes are available in trade pack to complement the Symmetry Door Furniture Collection.

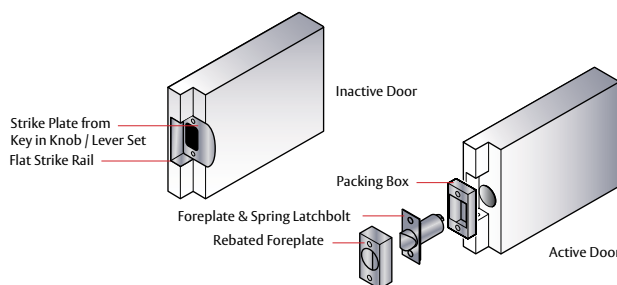

## Sliding Door Sets

Part Numbers	Description	Function
7300	Square Sliding Doorset	Privacy
7350	Square Sliding Doorset	Passage
7506	Square Sliding Doorset	Flush Pull
7400	Round Sliding Doorset	Privacy
7410	Round Sliding Doorset	Passage & Latchset
7444	Round Sliding Doorset	Entrance
7450	Round Sliding Doorset	Flush Pull

Symmetry Sliding Doorsets suit most sliding cavity doors. Available in entrance (round), passage and privacy functions in display pack only.

**Note:** A wide selection of Flush Pulls, Latches and Strikes are available in trade pack to complement the Symmetry Door Furniture Collection.



Sliding Doorsets



Flush Pull



Flush Pulls



7444 Entrance Set



7450 Passage Set



7400 Privacy Set  
7410 Latch Set

# Symmetry® Key in Knob & Key in Lever

## Ordering Procedure

Sample part number 7010SSKA is made up of several sections. Choose your product by selecting an option from each section.

## Symmetry® Series



Locksets Series	Function	Finish	Packaging	Keying
701	0	SSS		KA

Lockset Series	Function	Finish	Packaging	Keying
Imperial 702	Entrance 0	Everbrass EVB	Display Pack DP	Special Keying-Residential Keyed Alike 5P 5KA
Manor 701	Passage 1	Chrome Plate CP	Trade Pack TP	Keyed Alike 6P 6KA
Vicinity 753	Privacy 2	Polished Brass PB		Project Keyed 5P 5PK
District 754	Dummy 5	Polished Stainless Steel PSS		Projected Keyed 6P 6PK
Element™ 755		Satin Chrome Brushed SC		Restricted Profile 5P 5RP
		Satin Stainless Steel SSS		

**Note:** Ordering 7010SSS without specifying keying requirements will be considered as a key to differ (KD)

## Function Table

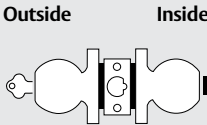
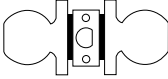
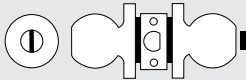
Function	Function #	Key in Knob or Key in Lever	Operation
Entrance	0		<p>For front doors, back doors and garages, when security is required.</p> <p><b>Outside:</b> Opened by knob when free. Key locks/unlocks both knobs.</p> <p><b>Inside:</b> Opened by knob when free. Tubular – Turn snib locks/unlocks both knobs. Cylindrical – Pushbutton will lock outside knob. Turning inside knob or outside key releases pushbutton automatically.</p> <p><b>Latch:</b> Deadlatch.</p>
Passage	1		<p>For passage, hall and closet doors, when no locking is required.</p> <p><b>Outside/Inside:</b> Opened by knob at all times.</p> <p><b>Latch:</b> Plainlatch.</p>
Privacy	2		<p>For use in bedrooms, bathrooms and toilets, where privacy is required. Includes kick off feature.</p> <p><b>Outside:</b> Opened by knob when free. Includes emergency release – locked door can be opened by coin or screwdriver.</p> <p><b>Inside:</b> Opened by knob when free. Tubular – Turn snib locks/unlocks both knobs. Cylindrical – Pushbutton will lock outside knob. Turning inside knob releases pushbutton automatically and will unlock outside knob.</p> <p><b>Latch:</b> Plain latch.</p>
Dummy Knob	5		<p>For use when only a door pull is required. Fixed knob without latch or lock. Decorative door pull. Knob will not turn.</p>

# Enable® Series Key in Lever Locksets



The new AS1428.1 Lockwood compliant leverset features a right angle return of 20mm length and good clearance from the door to prevent fingers slipping off during use. A push button on the interior side lever of the Exterior and Privacy Sets allows a single action egress function. This leverset is designed to enable positive grip and is suitable for door thickness of 35mm to 45mm.

## Door Clearance

To ensure correct functioning of the lockset, the clearance between the door and frame should be at least 3mm.

## Features and Specifications

### Cylinder

- Available in Exterior, Privacy, Passage, Single Dummy, Storeroom, Classroom, Glass Door and Lever/ Knob Combination sets
- Supplied with a standard “PD” type cylinder keyed to C4 profile with two keys
- Suitable for residential and commercial applications

## Restricted Special Keying

Lockwood locks can be keyed to a number of controlled and/or specially keyed systems. These range from legally protected keys to protect against unauthorised duplication, which can also include specially designed key systems such as master key systems, which allow for different levels of mechanical access control.

## Product Details

<b>Backset</b>	60 to 70mm adjustable backset latch
<b>Door Thickness</b>	35 to 45mm
<b>Finishes</b>	Satin Chrome Brushed (SC)
<b>Handing</b>	Non handed
<b>Latch</b>	13mm projection
<b>Materials</b>	High purity zinc alloy. Concealed fixing screws

## Standards and Compliance



Lockwood Enable® Range Locksets have been successfully tested up to 2 hours (depending on type of doorsets) on fire door assemblies in accordance with Australian Standard AS1905.1-2015, Part 1: Fire Resistant Doorsets.



# Enable® Series Key in Lever Locksets

Enable® Series KNL

Part Number KL2D005C

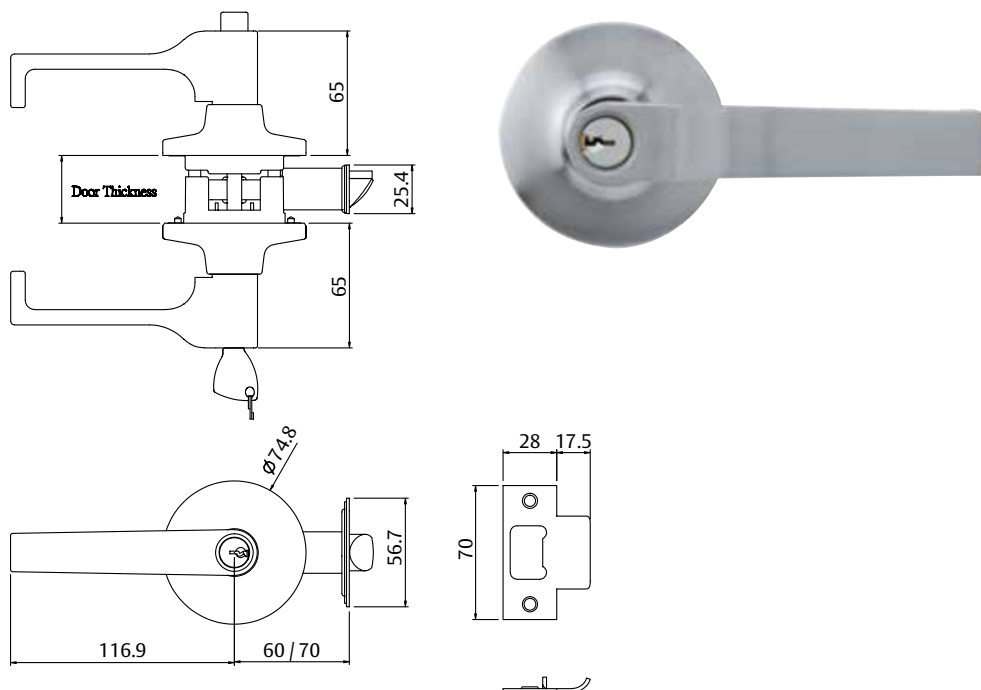

# Enable® Series Key in Lever Locksets

## Exterior Deadlatch

<b>Part Number</b>	KL2D005C
<b>Outside</b>	Unlocked by key or when push button inside is released
<b>Inside</b>	Operating lever unlocks push button. Closing door does not release push button

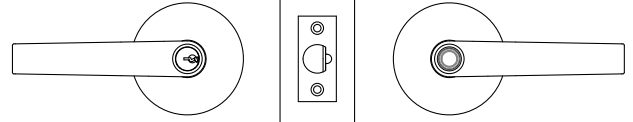

## Passage Set

<b>Part Number</b>	KL2D105C
<b>Outside</b>	Opened by lever at all times
<b>Inside</b>	Opened by lever at all times

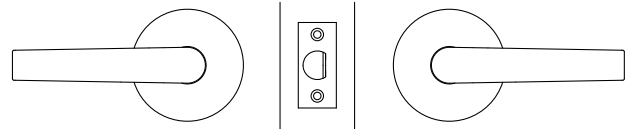

## Privacy Set

<b>Part Number</b>	KL2D205C
<b>Outside</b>	Locked by push button inside Unlocked by emergency release outside
<b>Inside</b>	Operating lever unlocks push button

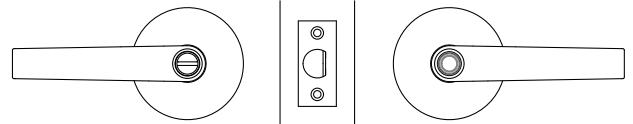

## Double Cylinder Glassdoor Set

<b>Part Number</b>	KL2D405C
<b>Outside</b>	Opened by lever from either side except when both levers are locked by key from either side
<b>Inside</b>	Opened by lever from either side except when both levers are locked by key from either side

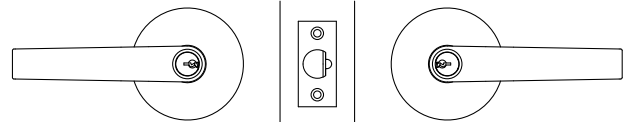

# Enable® Series Key in Lever Locksets

## Single Dummy

<b>Part Number</b>	KL2D50SC
<b>Outside</b>	Single dummy on one side of door
<b>Inside</b>	Single dummy on one side of door

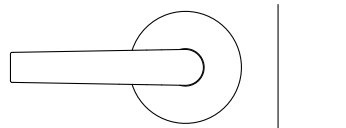

## Classroom Set

<b>Part Number</b>	KL2D60SC
<b>Outside</b>	Locked by key
<b>Inside</b>	Opened by lever at all times

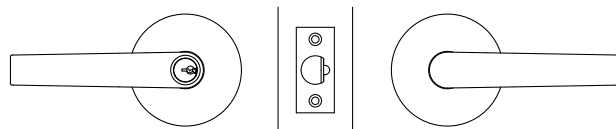

## Storeroom Set

<b>Part Number</b>	KL2D80SC
<b>Outside</b>	Always locked unless key is in lever permitting the lever to retract the latch
<b>Inside</b>	Opened by lever at all times

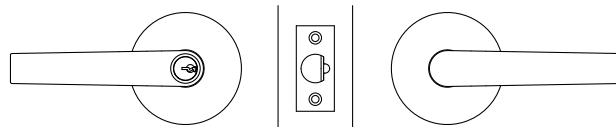

## Lever/Knob Combination Set

<b>Part Number</b>	KLK2D00SC
<b>Outside</b>	Knob unlocked by key or when push button is released
<b>Inside</b>	Operating lever unlocks push button. Closing door does not release push button

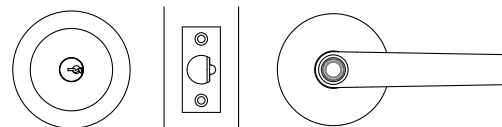

# Enable® Cylindrical Series Key in Lever Locksets



The new Lockwood Enable® Cylindrical Locksets are AS1428.1 compliant and incorporate a cylindrical chassis design housing a PD cylinder. This Lockwood Commercial Series offers a wide range of functions and is available in both 60mm and 70mm backsets. The lever is designed to enable positive grip to prevent fingers slipping off during use. A push button on the interior lever of the Exterior and Privacy Sets allows a single action egress function.

The new Lockwood Enable® Cylindrical Lockset range is available in Trade Pack and is suitable for a broad range of applications.

## Door Clearance

To ensure correct functioning of the lockset, the clearance between the door and frame should be at least 3mm.

## Features and Specifications

### Cylinder

- Standard “PD” type cylinder keyed to C4 profile with two keys
- Available in Exterior, Privacy, Passage, Dummy, Storeroom, Classroom and Glass Door sets

### Restricted Special Keying

Lockwood locks can be keyed to a number of controlled and/or specially keyed systems. These range from legally protected keys to protect against unauthorized duplication, which can also include specially designed key systems such as master key systems, which allow for different levels of mechanical access control.

## Product Details

<b>Backset</b>	Standard 70mm backset but 60mm also available
<b>Door Thickness</b>	35 – 46mm
<b>Finishes</b>	Satin Chrome Brushed (SC)
<b>Handing</b>	Handing is field changeable
<b>Latch</b>	Stainless Steel latch bolt

## Standards and Compliance



Lockwood Enable® Cylindrical Range Locksets have been successfully tested up to 2 hours (depending on type of doorsets) on fire door assemblies in accordance with Australian Standard AS1905.1-2015, Part 1: Fire Resistant Doorsets.

# Enable® Cylindrical Series Key in Lever Locksets

Enable® Cylindrical Series

Part Number KL17D00SC

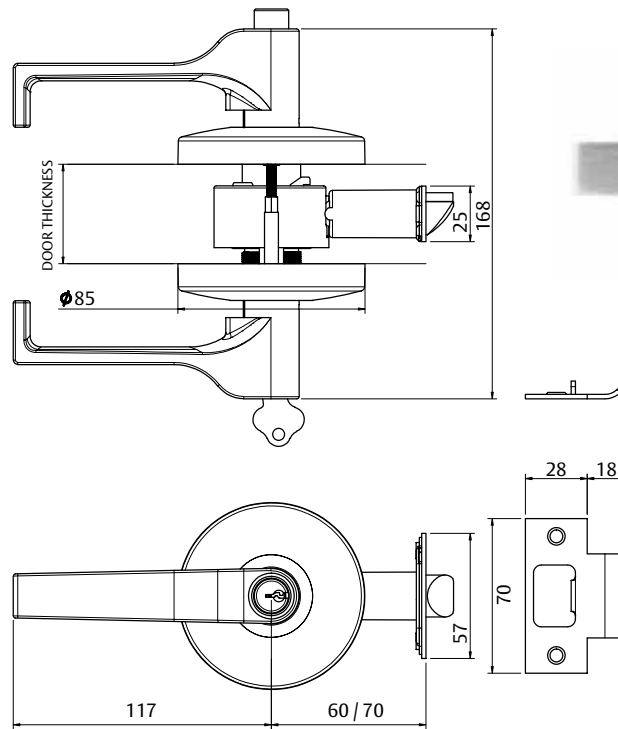

# Enable® Cylindrical Series Key in Lever Locksets

## Exterior Deadlatch

**Part Number** KL17D00SC (70mm backset)  
KL16D00SC (60mm backset)

**Outside** Opened by handle when unlocked. Key unlocks exterior handle.

**Inside** Opened by handle at all times. Push button locks exterior handle.

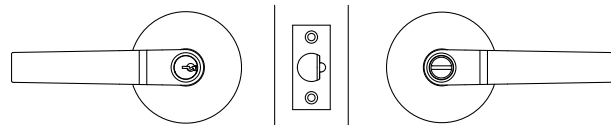

## Passage Set

**Part Number** KL17D10SC (70mm backset)  
KL16D10SC (60mm backset)

**Outside** Opened by handle at all times.

**Inside** Opened by handle at all times.

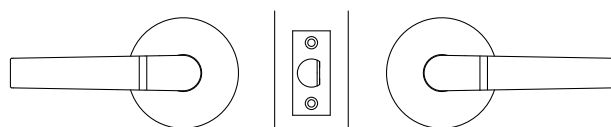

## Privacy Set

**Part Number** KL17D20SC (70mm backset)  
KL16D20SC (60mm backset)

**Outside** Opened by handle when unlocked. Coin or screwdriver in emergency button unlocks handle.

**Inside** Opened by handle at all times. Push button locks exterior handle.

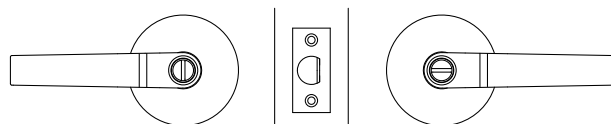

## Glass Door Set

**Part Number** KL17D40SC (70mm backset)  
KL16D40SC (60mm backset)

**Outside** Opened by handle when unlocked. Key locks or unlocks both handles.

**Inside** Opened by handle when unlocked. Key locks or unlocks both handles.

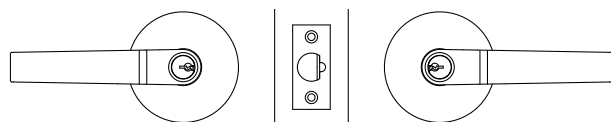

# Enable® Cylindrical Series Key in Lever Locksets

## Dummy Set

<b>Part Number</b>	KL17D50SC
<b>Outside</b>	For use where only a door pull is required.
<b>Inside</b>	For use where only a door pull is required.

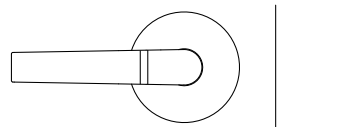

## Classroom Set

<b>Part Number</b>	KL17D60SC (70mm backset) KL16D60SC (60mm backset)
<b>Outside</b>	Opened by handle when unlocked. Key locks or unlocks exterior handle.
<b>Inside</b>	Opened by handle at all times.

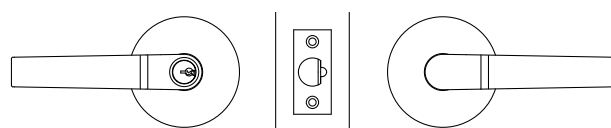

## Storeroom Set

<b>Part Number</b>	KL17D80SC (70mm backset) KL16D80SC (60mm backset)
<b>Outside</b>	Opened by key only. Outside handle is rigid at all times.
<b>Inside</b>	Opened by handle at all times.

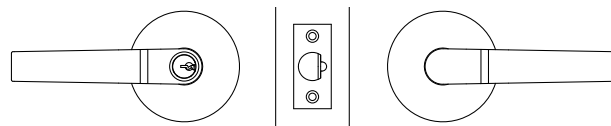

## Latches

Part Numbers	Function
SPL/DL60/SC	Lockwood Enable® Cylindrical Deadlatch 60mm
SPL/DL70/SC	Lockwood Enable® Cylindrical Deadlatch 70mm
SPL/PL60/SC	Lockwood Enable® Cylindrical Plain Latch 60mm
SPL/PLP60/SC	Lockwood Enable® Cylindrical Privacy Latch 60mm



**ASSA ABLOY**

**Lockwood** is the leading brand in the Australian locking industry. With an established reputation for high quality products, this iconic brand provides a wide range of locking solutions to residential housing, commercial, semi-commercial, building and industrial application markets. Lockwood is supported by an extensive distribution and after-sales support network. Our customers include retailers, architects, trade and industrial personnel, locksmiths and security dealers.

**ASSA ABLOY** is the global leader in door opening solutions, dedicated to satisfying end-user needs for security, safety and convenience.

**ASSA ABLOY** is represented in all major regions, in both mature and emerging markets, with leading positions in Australia, Europe and North America.

**25YEAR  
MECHANICAL  
WARRANTY**

### **The Lockwood 25 Year Mechanical Warranty**

Our belief that we manufacture the finest premium products available in today's market place is backed by the Lockwood 25 Year Mechanical Warranty, ensuring that Lockwood continues to keep Australians safe by delivering security and peace of mind.

For warranty terms and conditions, please visit [www.lockweb.com.au](http://www.lockweb.com.au) or call **1300WARRANTY**

**ASSA ABLOY Opening Solutions Australia**  
235 Huntingdale Road  
Oakleigh, Victoria, 3166  
Australia

**1300 LOCK UP (1300 562 587)**  
[lockweb.com.au](http://lockweb.com.au)

**ASSA ABLOY New Zealand Ltd**  
6 Armstrong Road  
Albany, Auckland, 0632  
New Zealand

[nzsales@assaabloy.com](mailto:nzsales@assaabloy.com)  
Telephone +64 9415 7111  
[assaabloyopeningsolutions.nz](http://assaabloyopeningsolutions.nz)

### **Disclaimer**

Whilst every effort has been made to ensure that the information (including product images and drawings) contained in this brochure is accurate at the time of publication, ASSA ABLOY Australia Pty Limited ("ASSA ABLOY") recommends that you consult ASSA ABLOY or its agents prior to placing an order to ascertain current information on specific products, as ASSA ABLOY reserves the right to make changes without notice. ASSA ABLOY will not be liable for any injury, loss or damage whatsoever, arising from any errors or omissions in the information contained in the brochure or arising from the use or application of the information contained herein. © 2018 copyright by ASSA ABLOY All rights reserved

