



# Door Closers



ASSA ABLOY

ASSA ABLOY, the global leader  
in door opening solutions

# Contents

<b>Introduction</b>	<b>1 - 2</b>
<b><u>CAM Action Door Closer Range</u></b>	<b>4 - 5</b>
<b>Lockwood 2516 CAM Action Door Closer with Slide Arm</b>	<b>4 - 5</b>
<b>Lockwood 2514 CAM Action Door Closer with Slide Arm</b>	<b>6 - 7</b>
<b>Lockwood 2557 Series Door Closer</b>	<b>8</b>
<b>Accessories – 2516 and 2514 Series</b>	<b>9</b>
<b><u>Hydraulic Door Closers</u></b>	<b>10</b>
<b>Features &amp; Specifications</b>	<b>11</b>
<b>Standard Features</b>	<b>12</b>
<b>7726 Door Closer Series</b>	<b>13</b>
<b>7726 Slide Arm Door Closer Series</b>	<b>14</b>
<b>7714 Door Closer Series</b>	<b>15</b>
<b>7714 Slide Arm Door Closer Series</b>	<b>16</b>
<b>7724 Door Closer Series</b>	<b>17</b>
<b>7724 Slide Arm Door Closer Series</b>	<b>18</b>
<b>3024 Door Closer Series</b>	<b>19</b>
<b>2024 Door Closer Series</b>	<b>20 - 21</b>
<b><u>Standard Hold Open Arm</u></b>	<b>22 - 23</b>
<b><u>Lockwood Electro Mechanical Door Control Systems</u></b>	<b>25</b>
<b>7726 Series</b>	<b>26 - 27</b>
<b><u>9024 Series Concealed In-Door Closer</u></b>	<b>29 - 31</b>
<b><u>Lockwood Door Stays</u></b>	<b>32</b>
<b>8001C Concealed Door Stay</b>	<b>32</b>
<b>8001S Surface Mounted Door Stay</b>	<b>33</b>

Designed and manufactured to exacting world standards. These world recognised standards ensure the highest possible quality, efficiency and reliable performance.

All models (except hold open) are tested and approved on Fire Doors in accordance with Australian standard AS1905:1:1997 Fire resistant door sets.

New multi functional designs offer the specifier, stockist or the installer outstanding versatility and low inventory levels.

Effective door installation requires that the door and frame be of sufficient strength or reinforced to ensure secure anchorage of the door closer unit.

A door fitted with a door closer must be hung on good quality aligned hinges so that the door swings freely without bias in both directions.

The closed door must be clear in the door frame and when a lock is fitted the latch bolt must engage freely within the strike.

When specifying manually operated door closers the following should be considered: door size, in particular width of door; door weight; type of installation; environmental conditions; location of door; operation frequency of door; the people using the door.

Door size and the pressure exerted on the surface area of the door due to wind gusts or air conditioning and the spring strength required to hold or close the door against this pressure must be considered along with the ability of the user to exert the force necessary to push or pull the door open. The location of door furniture will influence the leverage available to the person opening the door.



# Door Closers

Selection of door closer size is judged in two ways.

1. Does the door closer have the strength to effectively close the door against unexpected air pressures?
2. Is the door closer oversized for the application and therefore affecting the ease of operation?

Efficiency of the door closer also has a major bearing on ease of operation. For optimum performance it is essential that a highly efficient door closer of a correct size is selected.

The use of spring strength adjustability, which allows fine tuning of strength on site, has simplified this task but not removed all of the guesswork. With more architects and engineers becoming conscious of the problems caused by incorrect selection of door closer strength, it has become the responsibility of manufacturers to provide better technical information, such as closing torque and efficiency of their products.

The following chart has been produced to cover most conditions. If you have an unusual application which you feel requires special consideration, please forward all relevant information to your local office and we will be happy to advise the best door control for your application.

Fire doors and pressurised stairwells pose significant challenges in ensuring closing and latching of fire doors. The problems are created by differential air pressures resulting from airconditioning systems, either on one or the other side of the door. To achieve complete fire safety, fire doors must latch securely at all times. If this performance is not achieved, the stairwell may be unsafe, and in the event of fire, loss of life and property may occur. Correct selection of door hardware is of paramount importance in ensuring that the appropriate operating standards are met.

Fire doors which open into a pressurised stairwell must meet the following criteria:

- the door must close against a pressure differential between the airconditioned floor area and non-airconditioned stairwell;
- the door must latch securely every time it closes;
- the door must be able to be opened with a force not exceeding 110N when the stairwell is pressurised; and
- the door must be protected from damage when it is opened by means of a backcheck action which is built into the door closer.

1300 LOCK UP (1300 562 587)  
[lockweb.com.au](http://lockweb.com.au)

## Notes:

- Always round up to the next door width (ie for 870 mm door use 950 mm).
- If parallel arm installation, then use next door width door line (ie, for 830 mm door use 950 mm).
- For internal doors deduct 200 mm from actual door width (ie for 1250 mm internal door use 1050 line).
- This chart is based on normal climatic conditions (ie pressure differential of 30Pa or wind of 15 knots).
- If more severe conditions are expected then use the next door width or consult the office in your location (refer back page).
- When specifying parallel arm and slide rail functions, allowance should be made for the following power loss:

## Parallel Arm Mounting (7700/3024/2024 Series Rack and Pinion Range)

Approximately 20 per cent power loss

## Slide Rail Mounting (7700/3024/2024 Series Rack and Pinion Range)

Approximately 30 per cent power loss

## Power Selection Chart

This chart will be most useful in selecting the correct door closer. Simply identify the dimensions of the appropriate door and select the recommended door closer.

The chart is intended as a guide only and as such the following variations should be taken into account when making your selection:

- Environmental factors such as the effect of wind or airconditioning pressures.
- An unsheltered external door is a door on which prevailing wind gusts will directly produce a "sail area" affect.
- A sheltered external door is a door way which is protected by a wind break or wall, which acts as a barrier against direct wind gusts.

## Closer Selection Chart

Recommended Door Width	Door Weight (kg) Max	Closer PowerSize	ClosingTorque (Nm)
750	20	1	9 - <13
850	40	2	13 - <18
950	60	3	18 - <26
1100	80	4	26 - <37
1250	100	5	37 - <54
1400	120	6	54 - <87
1600	160	7	87 - <140



# Door Closers

## CAM Action Door Closer Range

### Lockwood 2516 CAM Action Door Closer with Slide Arm

The Lockwood 2516 CAM Action Door Closer is a premium, high quality door closing device. When opening a door fitted with a Lockwood 2516 CAM Action Door Closer, the force required is less than that of a rack and pinion type door closer, and continues to decrease through the opening arc.

This aesthetically appealing, narrow profile CAM Action Door Closer is suited for public and commercial applications where children, the elderly and the disabled are likely to be using the door. For disabled toilet applications where a breakout feature is required, the double action of the mechanism allows the door to be operated in the opposite direction for easy access into the room.

The Lockwood 2516 is light to open, but its adjustable closing force is high enough for heavy duty applications. The 2516 is non-handed and therefore very easy to install – either on the inside of the door or on the door frame.

#### Features:

- Adjustable spring power from size EN 1 to 6
  - Delayed Action DA (Standard)
  - Easily adjustable arm height
  - Adjustable closing speed
  - Adjustable latching speed
  - Back check (BC) (Built in)
  - Hold open 2516-152 (additional part)
  - Opening damper 2516 - 153
  - Cast aluminium body manufactured from high-performance silicon alloy
  - Two pressure relief valves are a standard feature to protect against abuse
  - High efficiency: 70 – 80%
  - Standard finish
- |                       |     |
|-----------------------|-----|
| Satin stainless steel | SSS |
| Polished Brass        | PB  |
| Silver                | SIL |

- One Model (2516): Covers most applications. Right hand & left hand applications and pull-side/push side applications

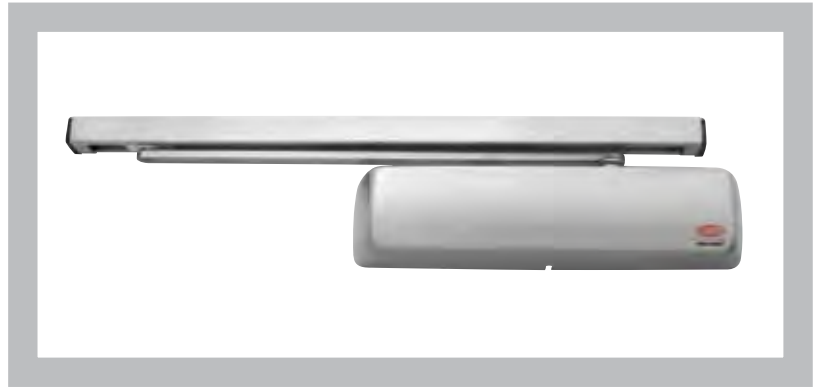

#### Fire Rated

The Lockwood 2516 CAM Action Door Closer has successfully been fire rated on fire door assemblies in accordance with Australian Standard AS 1905.1 - 2005: Fire-resistant doorsets.

#### Part Number

Satin Stainless Steel	<b>2516DASSS</b>
Gold Plated	<b>2516DAPB</b>
Silver	<b>2516DASIL</b>

#### Dimensions

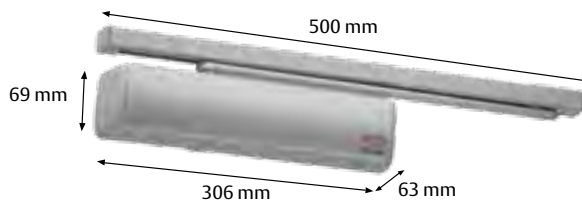

#### Movement Curve

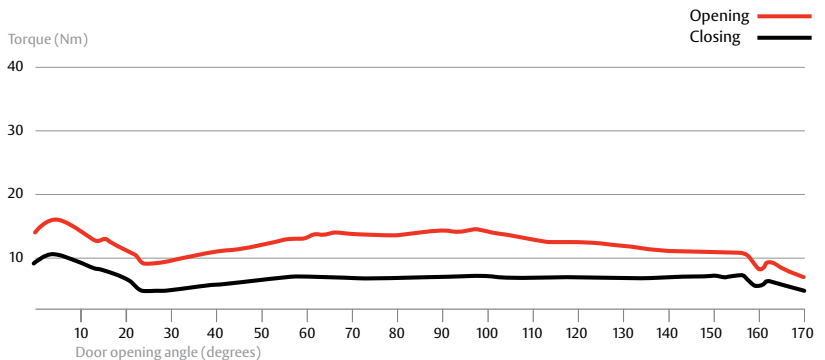

Note: Movement curve represents approximate forces required to operate a size 1 door closer.

The illustration is an approximation based on one set of parameters. Any change to these parameters will result in a variation of performance.

### Pull Side - Standard Mounting

Non hold-open permits door opening to 170°, and 160° when opening damper is used. When hold-open device is installed, the opening angle (hold-open) can be set to a maximum of 120°.

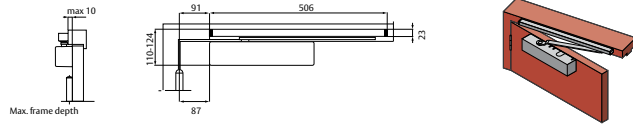

### Push Side - Standard Mounting

Non hold-open permits door opening to 120°, and 120° when opening damper is used. When hold-open device is installed, the opening angle (hold-open) can be set to a maximum of 120°.

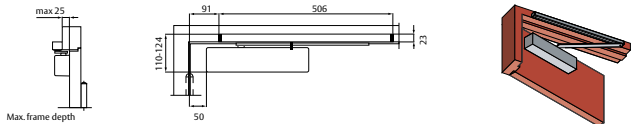

### Push Side - Over-Door Mounting

Non hold-open permits door opening to 120°, and 120° when opening damper is used. When hold-open device is installed, the opening angle (hold-open) can be set to a maximum of 120°.

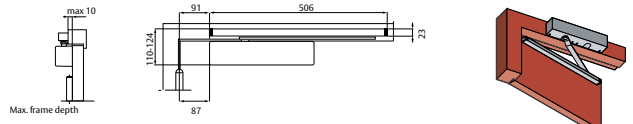

### Pull Side - Over-Door Mounting

Non hold-open permits door opening to 170°, and 160° when opening damper is used. When hold-open device is installed, the opening angle (hold-open) can be set to a minimum of 120°.

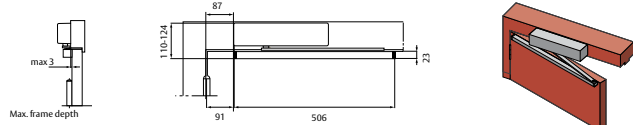

### Angle Plate

2516 - 104 SIL  
Allows the side rail to be installed below the door jamb. Required when the face of the door jamb exceeds 25 mm from the face of the door in the closed position.

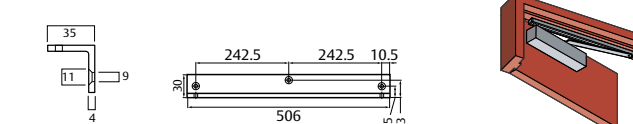

### Mounting Plate

2516 - 180 SIL  
For use on glazed doors with small top rail, this plate allows the closer to project below the top rail, at the same time concealing the back of the closer to enhance the appearance as seen through the glass.

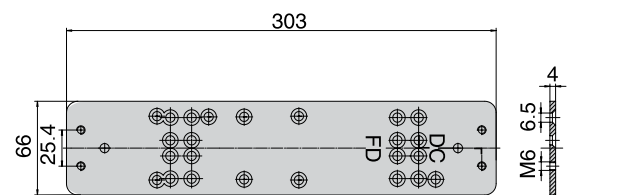

### Adjustment

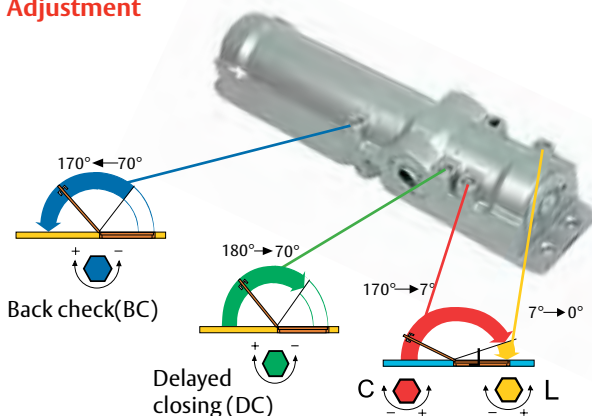

# Door Closers

## Lockwood 2514 CAM Action Door Closer with Slide Arm

The Lockwood 2514 Series is a non-handed CAM Action door closer. Due to the CAM design this premium door closer is light to open but still strong enough to close a door. Lockwood 2514 door closer can be adjusted to meet the requirements of a light door opening resistance and is ideal for both interior and exterior doors. The Lockwood 2514 Series is suitable for doors with a maximum door weight of 80kg and a door leaf width of 1100mm (sliding arm installation).

### Features:

- Adjustable spring power from size EN 1 to 4
- Cushioned back check (BC) 2516-153 - for fire door applications
- Easily adjustable arm height
- Adjustable closing speed
- Adjustable latching speed
- Hold open 2516-152
- Cast aluminium body manufactured from high-performance silicon alloy
- Two pressure relief valves are a standard feature to protect against abuse
- High efficiency: 70 – 80%
- Standard finish
 

Satin stainless steel	SSS
Silver	SIL
- One Model (2514): Covers most applications. Right hand & left hand applications and pull-side/push side applications.

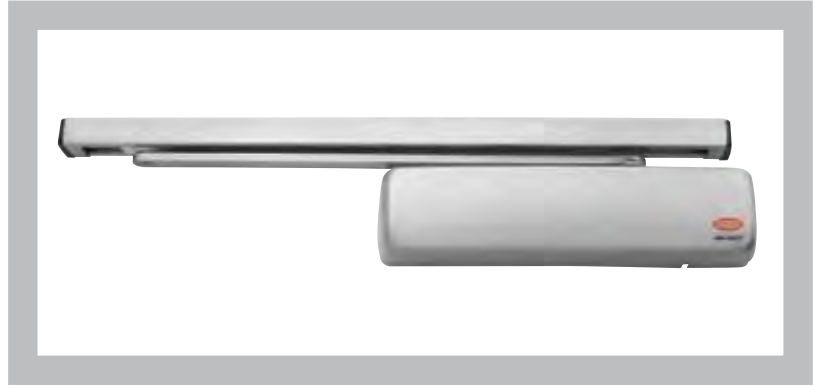

### Fire Rated

The Lockwood 2514 CAM Action Door Closer has successfully been fire rated on fire door assemblies in accordance with Australian Standard AS 1905.1 - 2005: Fire-resistant doorsets.

### Part Number

Satin Stainless Steel	<b>2514SSS</b>
Silver	<b>2514SIL</b>

### Dimensions

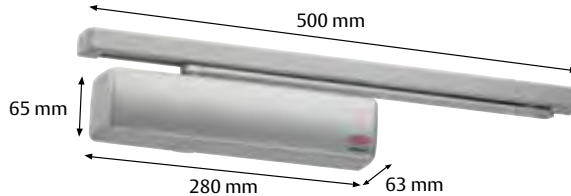

### Movement Curve

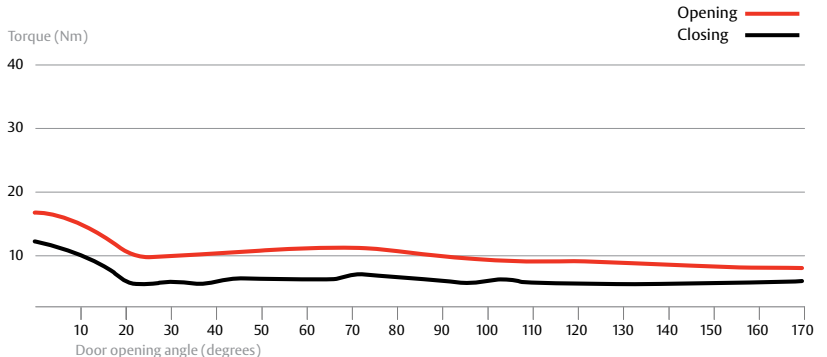

Note: Movement curve represents approximate forces required to operate a size 1 door closer. The illustration is an approximation based on one set of parameters. Any change to these parameters will result in a variation of performance.



## Pull Side - Standard Mounting

Non hold-open permits door opening to 170°, and 160° when opening damper is used. When hold-open device is installed, the opening angle (hold-open) can be set to a maximum of 120°.

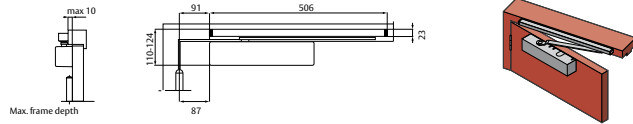

## Push Side - Standard Mounting

Non hold-open permits door opening to 120°, and 120° when opening damper is used. When hold-open device is installed, the opening angle (hold-open) can be set to a maximum of 120°.

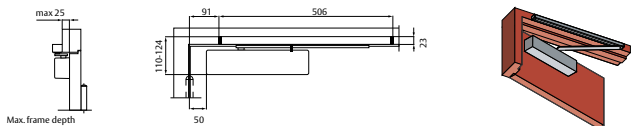

## Push Side - Over-Door Mounting

Non hold-open permits door opening to 120°, and 120° when opening damper is used. When hold-open device is installed, the opening angle (hold-open) can be set to a maximum of 120°.

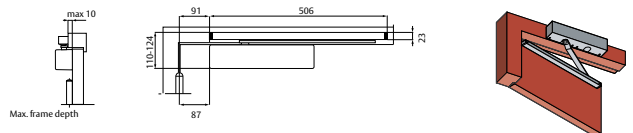

## Pull Side - Over-Door Mounting

Non hold-open permits door opening to 170°, and 160° when opening damper is used. When hold-open device is installed, the opening angle (hold-open) can be set to a minimum of 120°.

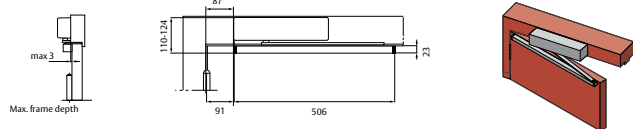

## Angle Plate

2516 - 104 SIL

Allows the side rail to be installed below the door jamb. Required when the face of the door jamb exceeds 25 mm from the face of the door in the closed position.

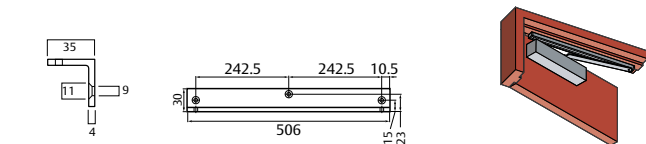

## Mounting Plate

2516 - 180 SIL

For use on glazed doors with small top rail, this plate allows the closer to project below the top rail, at the same time concealing the back of the closer to enhance the appearance as seen through the glass.

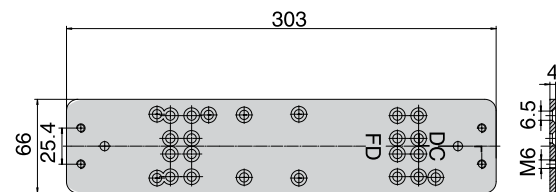

## Adjustment

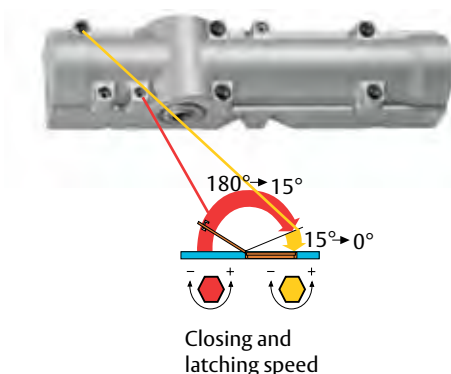

# Door Closers

## Lockwood 2557 Series Door Closer

The Lockwood 2557 Series is suitable for use on internal and external doors and is an ideal solution for extremely heavy doors. Maximum door weight 160kg and door leaf width 1600mm with standard arm installation.

### Features:

- Adjustable closing force size EN 5-7 according EN1154
- Separate adjusting valves for closing and latching speed
- Back Check (BC) as a standard feature
- Wide operating temperature range: -35°C to +45°C
- Adjustable closing latching and back check valves
- Easy adjustment of arm height (14 mm)
- Two pressure relief valves to protect against abuse
- Die-cast aluminium body manufactured from high performance silicon alloy

**Note:** Parallel arm (push side) is not available on this model.

### Part Number

2557SIL

### Dimensions



### Opening Side

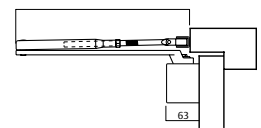
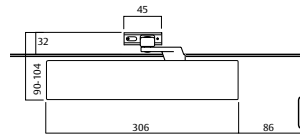
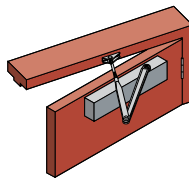

### Closing Side

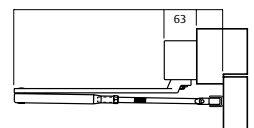
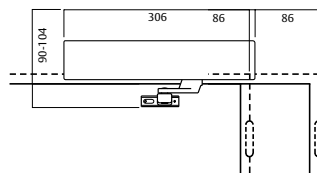
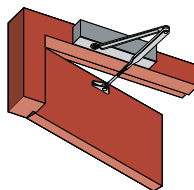

### Adjustment

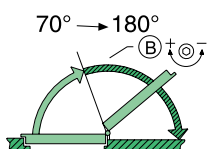
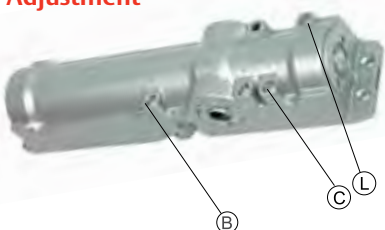

Back Check (BC)

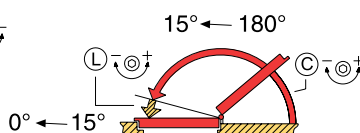

Closing and latching speed

## Accessories – 2516 and 2514 Series

### Adjustment

#### Adjusting the Arm Height

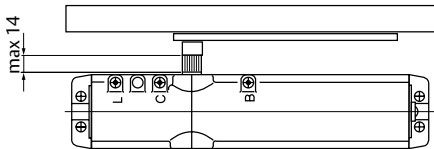

The arm height can be adjusted (by a maximum of 14 mm) by moving the grooved spindle in a vertical direction.

#### Angle Plate – 2516 - 104 SIL

Allows the side rail to be installed below the door jamb. Required when the face of the door jamb exceeds 25mm from the face of the door in the closed position.

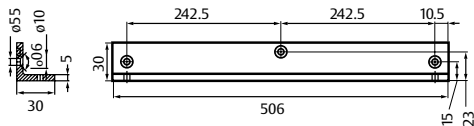

#### Drop Plate/Glass Door Trim Plate – 2516 - 180 SIL

For use on glazed doors with small top rail, this plate allows the closer to project below the top rail, at the same time concealing the back of the closer.

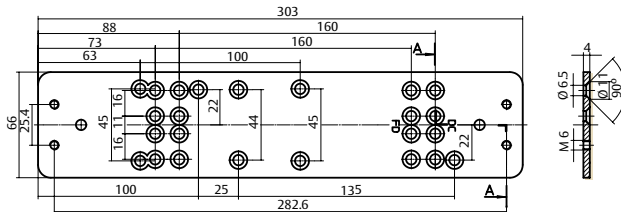

### Accessories For Sliding Arm

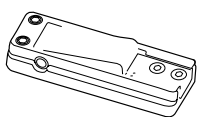

Hold Open Device  
2516-152

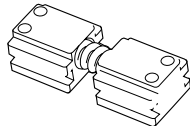

Opening Damper  
2516-153

### Closer Selection Chart

Door height should be a maximum of 2340mm

Recommended Door Width	Door Weight (kg) Max	Closer PowerSize	ClosingTorque (Nm)
750	20	1	9 - <13
850	40	2	13 - <18
950	60	3	18 - <26
1100	80	4	26 - <37
1250	100	5	37 - <54
1400	120	6	54 - <87
1600	160	7	87 - <140

# Door Closers

## Hydraulic Door Closers

Designed and manufactured to exacting world standards. These world recognised standards ensure the highest possible quality, efficiency and reliable performance.

All models (except hold open) are tested and approved on Fire Doors in accordance with Australian standard AS1905:1:1997 Fire resistant door sets.

New multi functional designs offer the specifier, stockist or the installer outstanding versatility and low inventory levels.

Effective door installation requires that the door and frame be of sufficient strength or reinforced to ensure secure anchorage of the door closer unit. A door fitted with a door closer must be hung on good quality aligned hinges so that the door swings freely without bias in both directions. The closed door must be clear in the door frame and when a lock is fitted the latch bolt must engage freely within the strike. When specifying manually operated door closers the following should be considered: door size, in particular width of door; door weight; type of installation; environmental conditions; location of door; operation frequency of door; the people using the door.

Door size and the pressure exerted on the surface area of the door due to wind gusts or airconditioning and the spring strength required to hold or close the door against this pressure must be considered along with the ability of the user to exert the force necessary to push or pull the door open. The location of door furniture will influence the leverage available to the person opening the door.



7726 Series Adjustable Power Hydraulic Door Closers



7714 Series Adjustable Power Hydraulic Door Closers



7724 Series Adjustable Power Hydraulic Door Closers



3024 Series Selectable Power Hydraulic Door Closers



2024 Series Hydraulic Door Closers

## Features and Specifications

### Handing

Lockwood door closers are non-handed, therefore final assemblies are suitable for clockwise or anticlockwise opening door.

### Backcheck

Backcheck is a standard feature on all models in this series. Backcheck cushions or slows the opening movement of the door prior to reaching final open position.

Backcheck intensity is adjustable to allow for door size, door weight and closing power. It is mandatory on all fire doors.

### Door Stops

Floor or wall mounted door stops should be fitted to prevent possible damage to the door unit or surrounds where a door may be subject to violent opening; to stop a door from being forced past the position where the arms are fully extended; or to stop a door at a specific position to clear feature walls, glass panels, furniture, etc.

### Delayed Action

The Delayed Action is an independent valve and can either be adjusted as part of the closing sequence or independently adjusted for delayed action.

Such doors are particularly suitable for use by the disabled, the aged and people with prams or trolleys.

### Sequence Selectors

When a pair of rebated doors are fitted with door closers it is essential that the doors close in their correct sequence. This closing sequence is achieved by the installation of a sequence selector.

### Materials

Extruded aluminium body with hard anodised coating. Alloy steel rack and pinion mechanism operated by silicon chrome alloy steel springs and forged steel arms.

### Overload Protection

Pressure relief valves are fitted to all units to prevent closer damage in the event of excessive force.

### Fire Test

Approved on fire door assemblies up to 4HR, in accordance with Australian Standards AS1905 Part 1 – Fire Resistant Doors 1984.

### Standard Hold-Open

The hold-open device is located on the link arm and is activated by a cam. The position of the cam is adjustable to suit the desired hold-open position up to 150°.

The operation of the hold-open device does not limit the angle to which the door may be opened, as the door may be pushed past the hold-open position without affecting its operation.

A firm push or pull on the door will release the hold-open device.

### Slide Rail Hold Open

Hold-open is a standard feature for all slide arm door closers. Can be adjusted or disabled at any angle of the open arc.

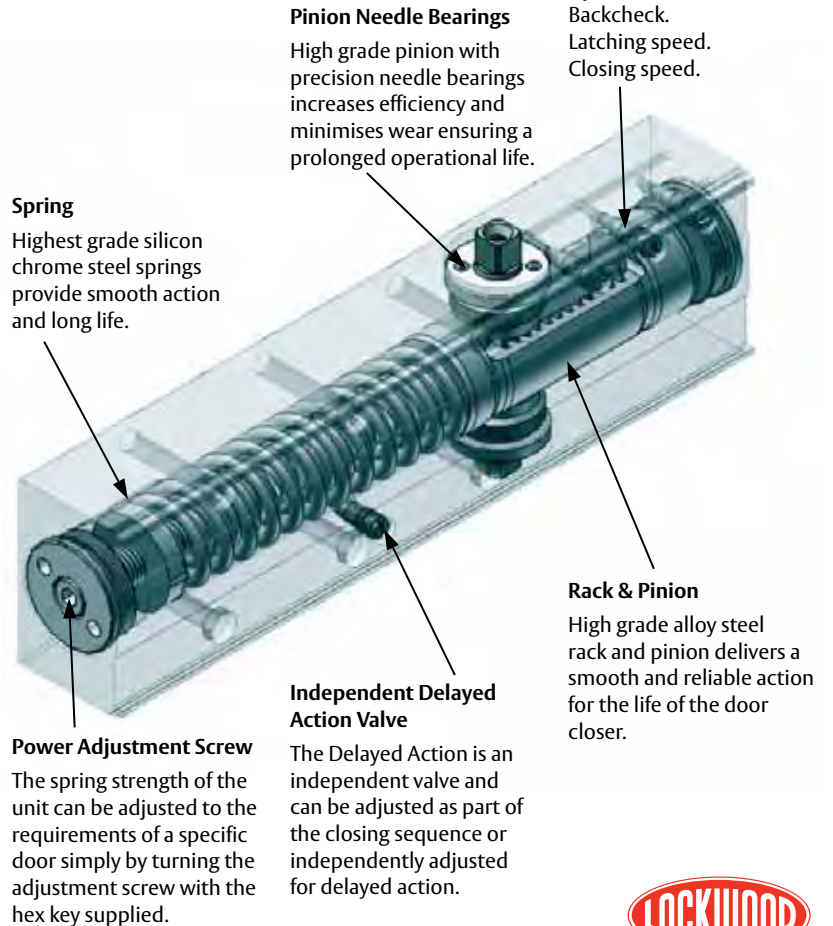

### Spring

Highest grade silicon chrome steel springs provide smooth action and long life.

### Pinion Needle Bearings

High grade pinion with precision needle bearings increases efficiency and minimises wear ensuring a prolonged operational life.

### Independently Adjustable

Hydraulic Valves  
Backcheck.  
Latching speed.  
Closing speed.

### Rack & Pinion

High grade alloy steel rack and pinion delivers a smooth and reliable action for the life of the door closer.

### Independent Delayed Action Valve

The Delayed Action is an independent valve and can be adjusted as part of the closing sequence or independently adjusted for delayed action.

### Power Adjustment Screw

The spring strength of the unit can be adjusted to the requirements of a specific door simply by turning the adjustment screw with the hex key supplied.



# Door Closers

## Standard Features

Primary Lock	7726	7714	7724	3024	2024
<b>Materials</b>					
Extruded Aluminium body with hard anodised coating	✓	✓	✓	✓	
Alloy Steel Rack & Pinion Mechanism	✓	✓	✓	✓	✓
Silicon Chrome Steel Alloy Springs	✓	✓	✓	✓	✓
Forged Steel Arms	✓	✓	✓	✓	✓
Fully Formed Stainless Steel Box Cover	✓	✓	✓	✓	✓
Clip-on Cover			✓	✓	
High Grade Pinion Needle Bearings	✓	✓	✓	✓	✓
<b>Power Adjustment</b>					
Adjustable Power	✓	✓	✓		
Adjustable Power - Position				✓	✓
<b>Power Size</b>					
Power Size 1		✓			
Power Size 2	✓	✓	✓	✓	✓
Power Size 3	✓	✓	✓	✓	✓
Power Size 4	✓	✓	✓	✓	✓
Power Size 5	✓				
Power Size 6	✓				
<b>Features</b>					
Backcheck	✓	✓	✓	✓	✓
Delayed Action	✓	✓			
Non-Handed	✓	✓	✓	✓	✓
Overload Protection	✓	✓	✓	✓	✓
Standard Arm	✓	✓	✓	✓	✓
Slide Arm	✓	✓	✓		
Over Door Mounting	✓	✓	✓	✓	✓
Standard Hold Open	✓	✓	✓	✓	✓
Slide Arm Hold Open	✓	✓	✓		
Fire Rated	✓	✓	✓	✓	✓
<b>Finish</b>					
Satin Stainless Steel	✓	✓	✓		
Polished Stainless Steel	✓	✓	✓		
Gold PVD on Stainless Steel	✓	✓			
Silver			✓	✓	✓
Gold			✓	✓	

## 7726 Door Closer Series

A range of adjustable power door closer units suitable for architectural and commercial applications.

### Standard Features

- Stainless Steel Cover;
- 2 – 6 Power Adjustable;
- Delayed Action;
- Adjustable Backcheck;
- Speed Controls;
- Overload Protection;
- Non-Handed;
- Regular, Parallel & Over Door mounting.

### Hold Open

Hold open can be set at any angle up to 150° of opening.

### Standard Finishes

Satin Stainless Steel	<b>SSS</b>
Polished Stainless Steel	<b>PSS</b>
Bright Gold	<b>GLD</b>



### FIRE RATED

Tested on fire door assemblies up to 4 hours in accordance with Australian Standard AS 1905.1-1997, Part 1: Fire-resistant doorsets



### 7726 Standard Arm

Closer installed on pull side of door. This mounting position permits opening of 180°.

Part Numbers	
Non hold open	7726
Hold Open	7726H

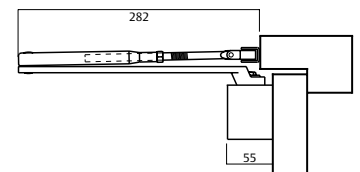
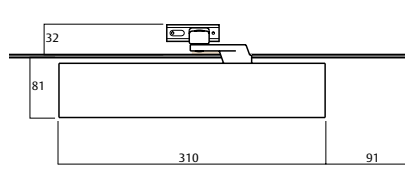
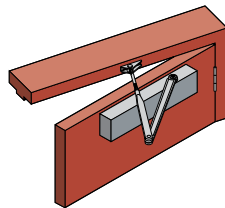

### 7726 Parallel Arm

Closer installed on push side of door. This mounting position permits opening of 180°.

Part Numbers	
Non hold open	7726
Hold Open	7726H

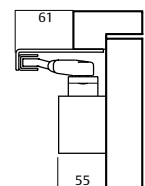
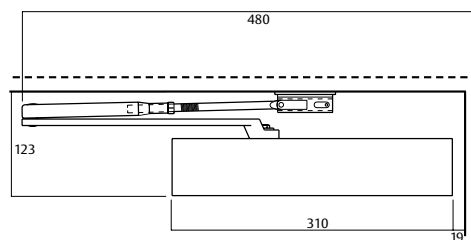
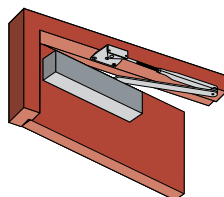

### 7726 Over Door Mounting

Closer installed on push side of door and top rail where conditions do not allow parallel mounting. This mounting position permits opening of 180°.

Part Numbers	
Non hold open	7726
Hold Open	7726H

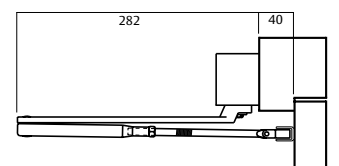
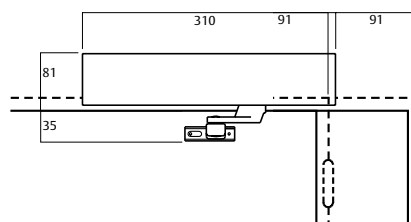
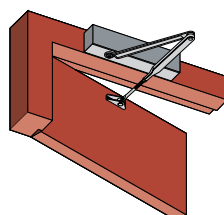

# Door Closers

## 7726 Slide Arm Door Closer Series

The Slide Arm Series permits smoother opening by way of reducing power as the door opens. Ideally suited for schools, hospitals or doors where children, disabled or the aged may enter.

### Standard Features

- Stainless Steel Cover;
- 2 – 5 Power Adjustable;
- Delayed Action;
- Adjustable Hold Open (Inclusive);
- Adjustable Backcheck;
- Speed Controls;
- Overload Protection;
- Non-Handed;
- Regular & Over Door mounting.



### Hold Open

Hold open angle is the same as opening angle.

### Standard Finishes

Satin Stainless Steel	<b>SSS</b>
Polished Stainless Steel	<b>PSS</b>
Bright Gold	<b>GLD</b>

### FIRE RATED

Tested on fire door assemblies up to 4 hours in accordance with Australian Standard AS 1905.1-1997, Part 1: Fire-resistant doorsets

### 7726 Slide arm Pull Slide

Closer installed on pull side of door. This mounting position permits opening of 130°.

#### Part Numbers

7726SR

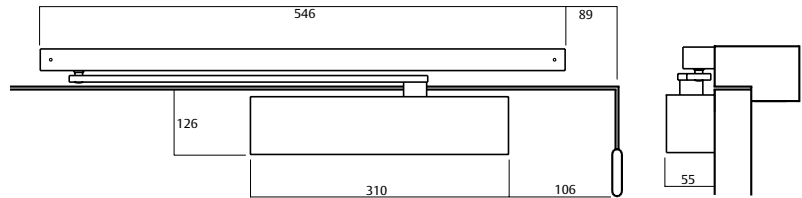
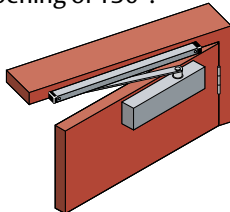

### 7726 Slide Arm Push Side

Closer installed on push side of door. This mounting position permits opening of 180°.

#### Part Numbers

7726SR

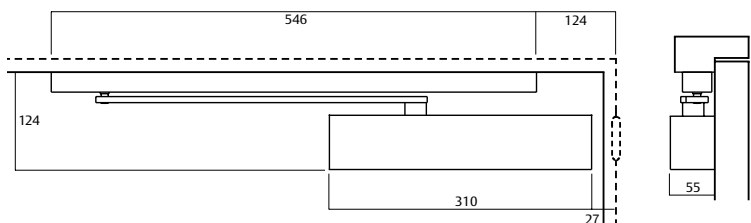
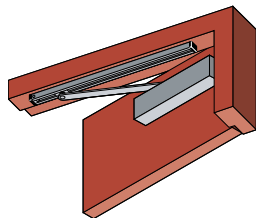

### 7726 Slide Arm Over Door Mounting Push Side

Closer installed on push side of door and top rail where conditions do not allow parallel mounting. This mounting position permits opening of 180°.

#### Part Numbers

7726SR

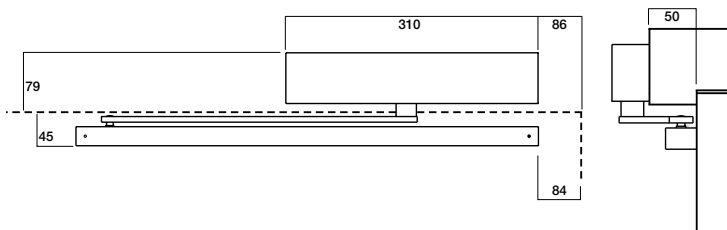
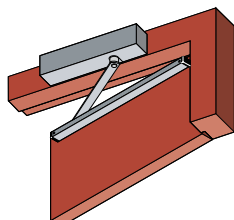

1300 LOCK UP (1300 562 587)  
lockweb.com.au



## 7714 Door Closer Series

A range of adjustable power door closer units suitable for architectural and commercial applications.

### Standard Features

- Stainless Steel Cover;
- 1 – 4 Power Adjustable;
- Delayed Action;
- Hold Open;
- Adjustable Backcheck;
- Speed Controls;
- Overload Protection;
- Non-Handed;
- Regular, Parallel & Over Door mounting.

### Hold Open

Hold open can be set at any angle up to 150° of opening.

### Standard Finishes

Satin Stainless Steel	<b>SSS</b>
Polished Stainless Steel	<b>PSS</b>
Bright Gold	<b>GLD</b>



### FIRE RATED

Tested on fire door assemblies up to 4 hours in accordance with Australian Standard AS 1905.1-1997, Part 1: Fire-resistant doorsets



### 7714 Standard Arm

Closer installed on pull side of door. This mounting position permits opening of 180°.

Part Numbers	
Non hold open	7714
Hold Open	7714H

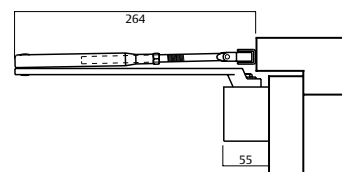
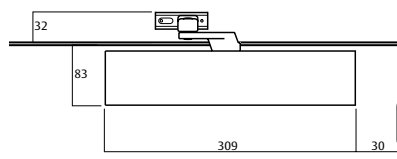
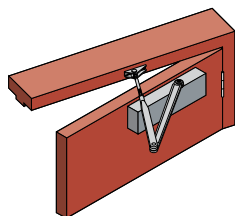

### 7714 Parallel Arm

Closer installed on push side of door. This mounting position permits opening of 180°.

Part Numbers	
Non hold open	7714
Hold Open	7714H

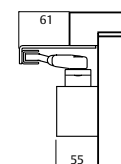
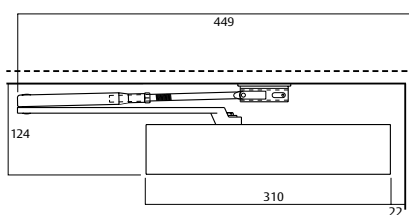
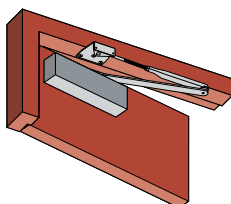

### 7714 Over Door Mounting

Closer installed on push side of door and top rail where conditions do not allow parallel mounting. This mounting position permits opening of 180°.

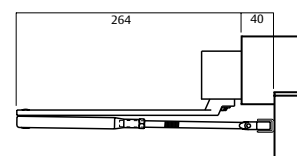
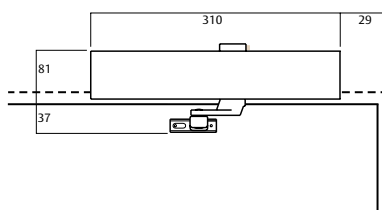
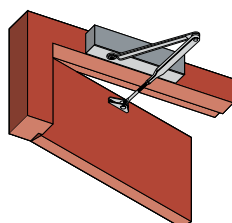

# Door Closers

## 7714 Slide Arm Door Closer Series

The Slide Arm Series permits smoother opening by way of reducing power as the door opens. Ideally suited for schools, hospitals or doors where children, disabled or the aged may enter.

### Standard Features

- Stainless Steel Cover;
- 1 – 3 Power Adjustable;
- Delayed Action;
- Adjustable Hold Open (Inclusive);
- Adjustable Backcheck;
- Speed Controls;
- Overload Protection;
- Non-Handed;
- Regular & Over Door mounting.



### Hold Open

Hold open angle is the same as opening angle.

### Standard Finishes

Satin Stainless Steel	<b>SSS</b>
Polished Stainless Steel	<b>PSS</b>
Bright Gold	<b>GLD</b>

### FIRE RATED

Tested on fire door assemblies up to 4 hours in accordance with Australian Standard AS 1905.1-1997, Part 1: Fire-resistant doorsets

### 7714 Slide Arm Pull Slide

Closer installed on pull side of door. This mounting position permits opening of 130°.

#### Part Numbers

7714SR

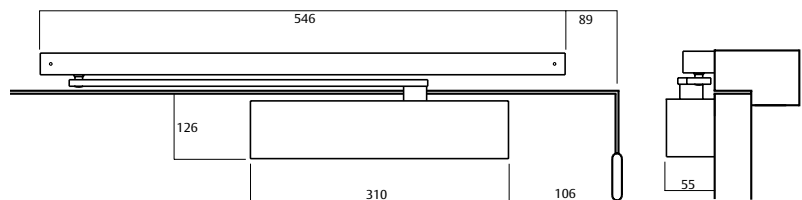
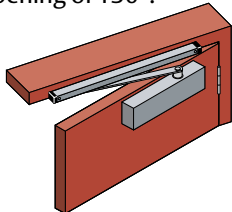

### 7714 Slide Arm Push Side

Closer installed on push side of door. This mounting position permits opening of 115°.

#### Part Numbers

7714SR

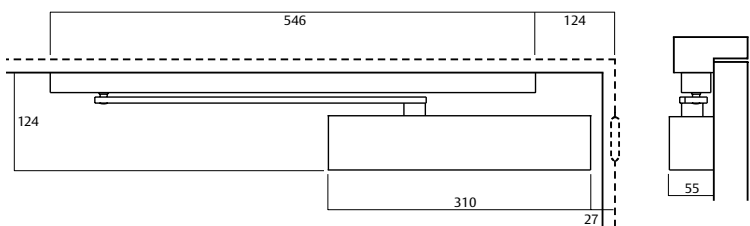
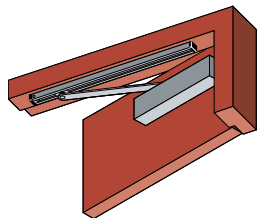

### 7714 Slide Arm Over Door Mounting Push Side

Closer installed on push side of door and top rail where conditions do not allow parallel mounting. This mounting position permits opening of 115°.

#### Part Numbers

7714SR

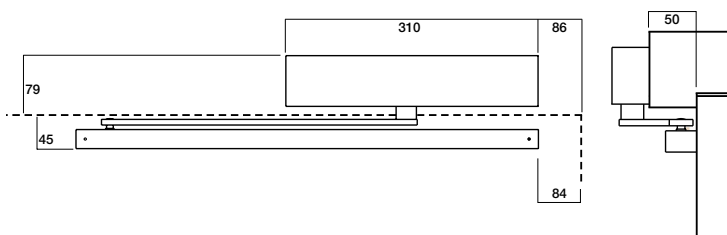
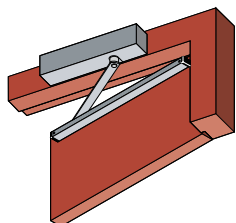

1300 LOCK UP (1300 562 587)  
lockweb.com.au

## 7724 Door Closer Series

A range of adjustable power door closer units suitable for architectural and commercial applications.

### Standard Features

- 2 – 4 Power Adjustable;
- Hold Open;
- Adjustable Backcheck;
- Speed Controls;
- Overload Protection;
- Non-Handed;
- Short Arm - to suit 400 mm width door. SP7724-130SIL

### Hold Open

Hold open can be set at any angle up to 150° of opening.

### Standard Finishes

- Satin Stainless Steel **SSS**
- Polished Stainless Steel **PSS**
- Bright Gold **GLD**



### FIRE RATED

Tested on fire door assemblies up to 4 hours in accordance with Australian Standard AS 1905.1-1997, Part 1: Fire-resistant doorsets



### 7724 Standard Arm

Closer installed on pull side of door. This mounting position permits opening of 130°.

Part Numbers	
Non hold open	7724
Hold Open	7724H

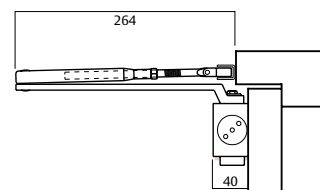
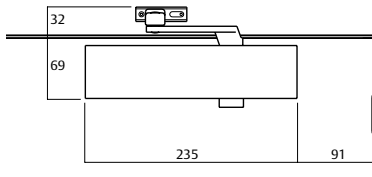
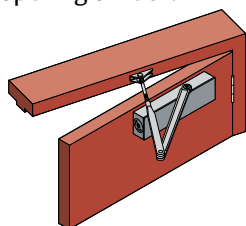

### 7724 Parallel Arm

Closer installed on push side of door. This mounting position permits opening of 180°.

Part Numbers	
Non hold open	7724
Hold Open	7724H

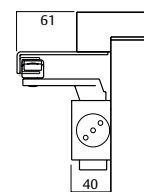
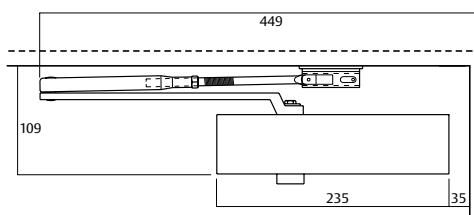
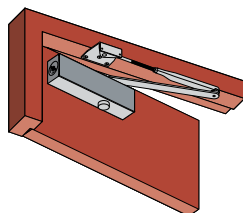

### 7724 Over Door Mounting

Closer installed on push side of door and top rail where conditions do not allow parallel mounting. This mounting position permits opening of 180°.

Part Numbers	
Non hold open	7724
Hold Open	7724H

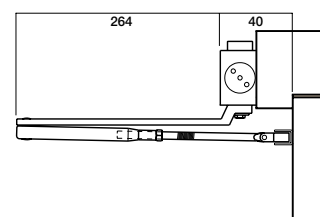
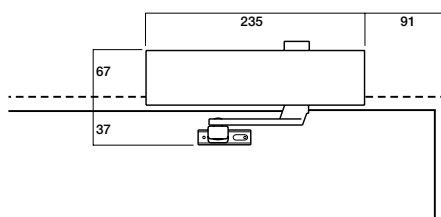
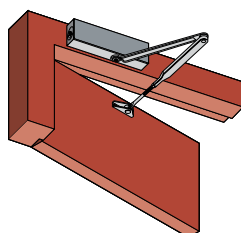

# Door Closers

## 7724 Slide Arm Door Closer Series

The Slide Arm Series permits smoother opening by way of reducing power as the door opens. Ideally suited for schools, hospitals or doors where children, disabled or the aged may enter.

### Standard Features

- 2 – 3 Power Adjustable;
- Adjustable Hold Open (Inclusive);
- Adjustable Backcheck;
- Speed Controls;
- Overload Protection;
- Non-Handed;
- Regular & Over Door mounting.

### Hold Open

Hold open angle is the same as opening angle.



### Standard Finishes

Satin Stainless Steel	SSS
Polished Stainless Steel	PSS
Silver	SIL

### FIRE RATED

Tested on fire door assemblies up to 4 hours in accordance with Australian Standard AS 1905.1-1997, Part 1: Fire-resistant doorsets

### 7724 Slide arm Pull Slide

Closer installed on pull side of door. This mounting position permits opening of 130°.

#### Part Numbers

7724SR

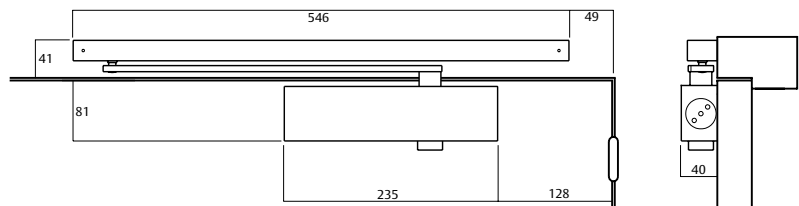
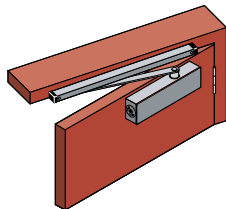

### 7724 Slide Arm Push Side

Closer installed on push side of door. This mounting position permits opening of 115°.

#### Part Numbers

7724SR

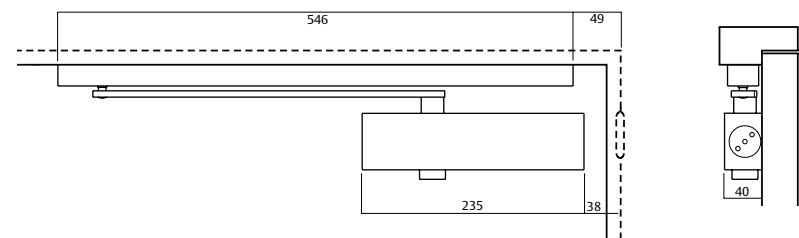
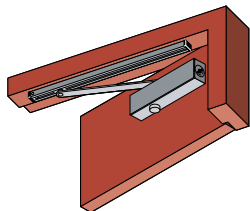

### 7724 Slide Arm Over Door Mounting Push Side

Closer installed on push side of door and top rail where conditions do not allow parallel mounting. This mounting position permits opening of 115°.

#### Part Numbers

7724SR

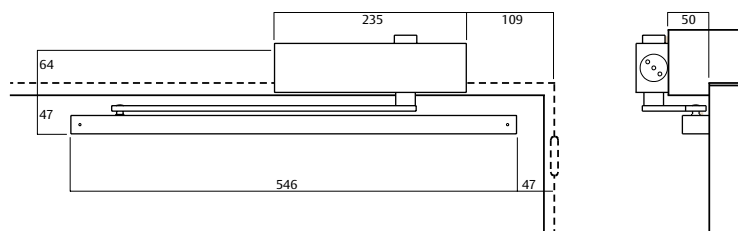
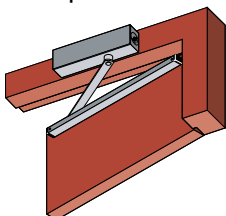

1300 LOCK UP (1300 562 587)  
lockweb.com.au

## 3024 Door Closer Series

A range of adjustable power door closer units suitable for architectural and commercial applications.

### Standard Features

- 2 – 4 Power Adjustable;
- Hold Open;
- Adjustable Backcheck;
- Speed Controls;
- Overload Protection;
- Non-Handed;
- Regular, Parallel & Over Door mounting.

### Hold Open

Hold open can be set at any angle up to 150° of opening.

### Standard Finishes

Gold **GLD**  
 Silver **SIL**  
 Other finishes available on request.

### FIRE RATED

Tested on fire door assemblies up to 4 hours in accordance with Australian Standard AS 1905.1-1997, Part 1: Fire-resistant doorsets



### 3024 Standard Arm

Closer installed on pull side of door. This mounting position permits opening of 180°.

Part Numbers	
Non hold open	3024
Hold Open	3024H

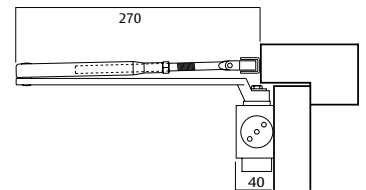
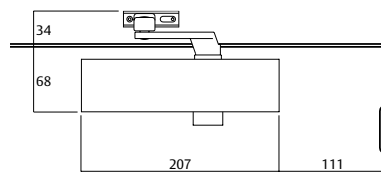
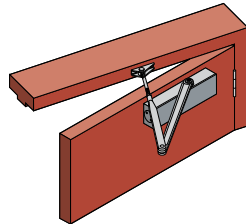

### 3024 Parallel Arm

Closer installed on push side of door. This mounting position permits opening of 180°.

Part Numbers	
Non hold open	3024
Hold Open	3024H

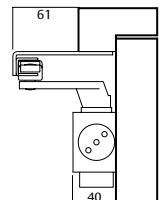
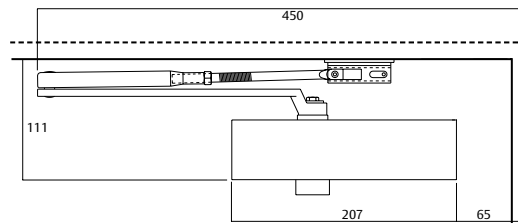
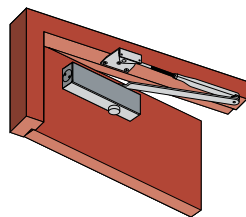

### 3024 Over Door Mounting

Closer installed on push side of door and top rail where conditions do not allow parallel mounting. This mounting position permits opening of 180°.

Part Numbers	
Non hold open	3024
Hold Open	3024H

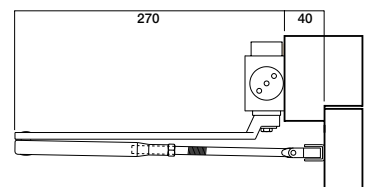
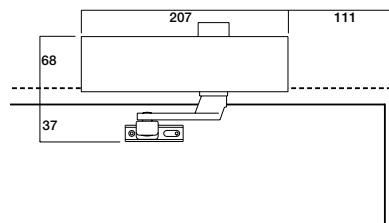
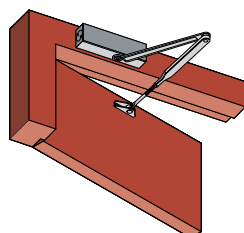

# Door Closers

## 2024 Door Closer Series

The Lockwood range of economy doorclosers is particularly quick and easy to install on most applications, ideally suitable where cost is a high priority. Multi position mounting template enables adjustment on site to meet most conditions also low stock holding as one model will cover 3 power sizes. Suitable for doors up to 1100 mm in width .

### Specifications

#### Backcheck (adjustable)

Available in this series, specify BC if required. Backcheck cushions or slows the door prior to reaching final opening position.

#### Hold open

Available in this series, specify HO.

#### Handing

Non handed. Suitable for left or right hand doors.

#### Adjustment

Independent valves control closing and latching speeds which can be readily adjusted on site when required.

#### Fire doors

##### FIRE RATED

Approved on fire door assemblies up to 4 HR, in accordance with Australian Standards AS1905 Part 1 - Fire Resistant Doors 1984. Backcheck is required for all fire door applications. NOTE: Hold-open option is not approved on any fire door.

#### Mechanism

Rack and pinion design.



#### Materials

High purity die cast aluminium housing with hardened steel rack and pinion mechanism.

#### Finish

Silver baked enamel.

#### Power Selection Charts

The power of the door closer is altered by adjusting the position of the door closer body on the mounting template.

## 2024 Door Closer Series

### Functions in Detail

All products include parallel arm bracket; Multi strength mounting (One model covers size 2, 3, and 4); Parallel Arm Size 2 and 3; 4HR Fire Rating (backcheck version).

### 2024 Standard Arm

Closer installed on pull side of door. Standard mounting position permits door opening of 180°. If hold-open is installed the hold-open range is 80° to 165°.

- Part Numbers**
- 2024SIL
  - 2024BCSIL
  - 2024HSIL

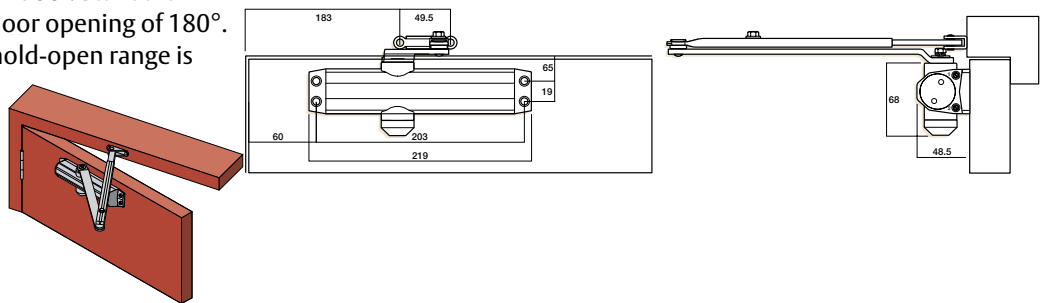

### 2024 Parallel Arm

Closer installed on push side of door. Standard mounting position permits door opening of 180°. If hold-open is installed the hold-open range is 80° to 165°.

- Part Numbers**
- 2024SIL
  - 2024BCSIL
  - 2024HSIL

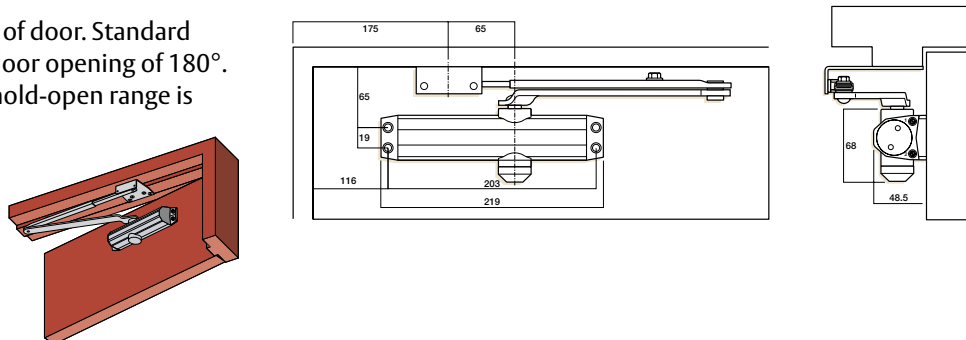

### 2024 Over Door Mounting

Closer installed on push side top rail where door conditions do not allow parallel mounting. Standard mounting position permits door opening of 180°. If hold-open is installed the hold-open range is 80° to 165°.

- Part Numbers**
- 2024SIL
  - 2024BCSIL
  - 2024HSIL

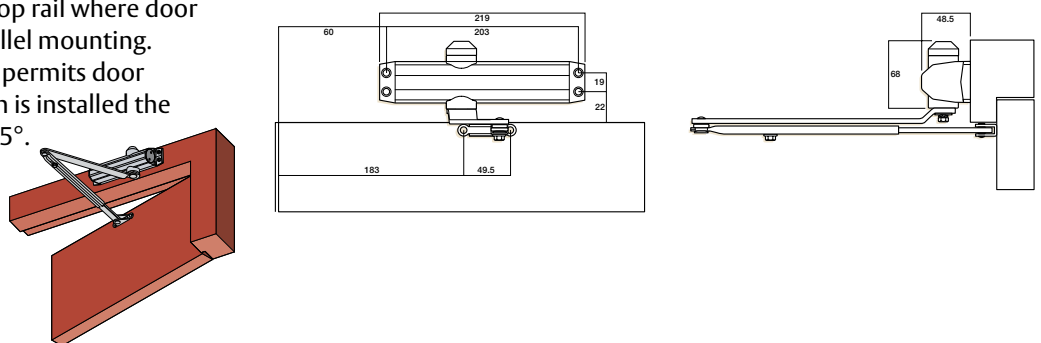

### 2024 Metal Door Mounting

Closer installed on push side of door to suit doorstop of 15 mm. Standard mounting position permits door opening of 180°. If hold-open is installed the hold-open range is 90° to 165°.

- Part Number**
- 2024BCPOSIL

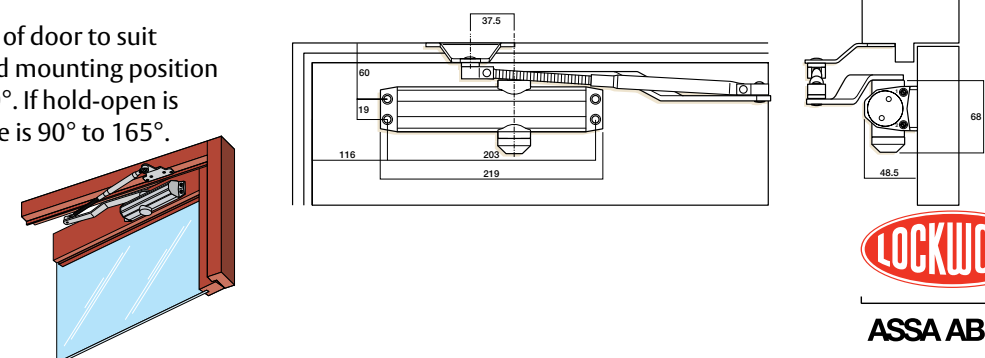

ASSA ABLOY

# Door Closers

## Standard Hold Open Arm

### Description

- Surface mounted on push or pull side of door;
- To hold the door open at any angle until the hold-open function is positively released by a slight pull action;
- Adjustable up to 150° angle of the door closer opening range.

### Features & Specifications

The Hold Open Arm is suitable for both standard and parallel mounting.

The link arm is forged steel with a steel main arm finished in baked enamel.

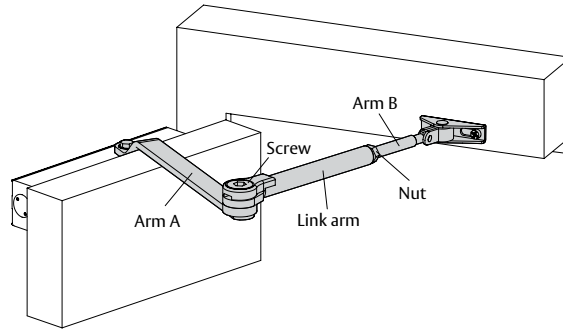

## Slide Arm Hold open

### Adjustable Hold Open Device

To set the hold open angle move hold open device to required position and firmly tighten screw.

If Hold Open is not required do not tighten HO screw.

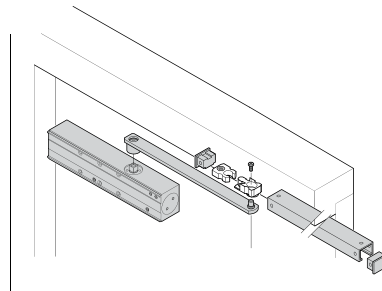

## Delayed Action

The Delayed Action is an independent valve and can either be adjusted as part of the closing sequence or independently adjusted for delayed action.

### Closing sequence with Delayed Action

D = 130° - 70° Control door speed with Delayed Action valve

B = 70° - 15° Control door speed with Closing valve

A = 15° - 0° Control door speed with Latching valve

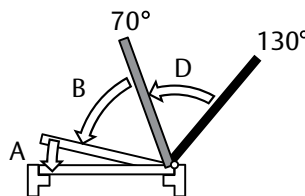



## Standard Hold Open Arm

### 7726/7714 Drop Plate

Drop plate is available for fixing to doors with a small top rail. Four drilled and tapped holes are provided for easy installation of door closer.

Fitting of drop plate does not lower the position of door closer.

Suitable for Parallel Arm & Slide Arm. Push side applications only.

#### Part Numbers

7726-180SIL

### 7724 Drop Plate

Drop plate is available for fixing to doors with a small top rail. Four drilled and tapped holes are provided for easy installation of door closer.

Fitting of drop plate does not lower the position of door closer.

Suitable for Parallel Arm & Slide Arm. Push side applications only.

#### Part Numbers

7724-180SIL

### 3024 Drop Plate

Drop plate is available for fixing to doors with a small top rail. Four drilled and tapped holes are provided for easy installation of door closer.

Fitting of drop plate does not lower the position of door closer.

Suitable for Parallel Arm & Slide Arm. Push side applications only.

#### Part Numbers

3024-180SIL

### 3024 Trim Plate

When a closer is mounted to a glazed door the closer may project below the top rail.

To enhance the appearance as seen through the glass, a trim plate is available that conceals the back of the closer.

Also for regular and over door mounting on narrow aluminium frames. Pull side applications only.

#### Part Numbers

3024-173SIL

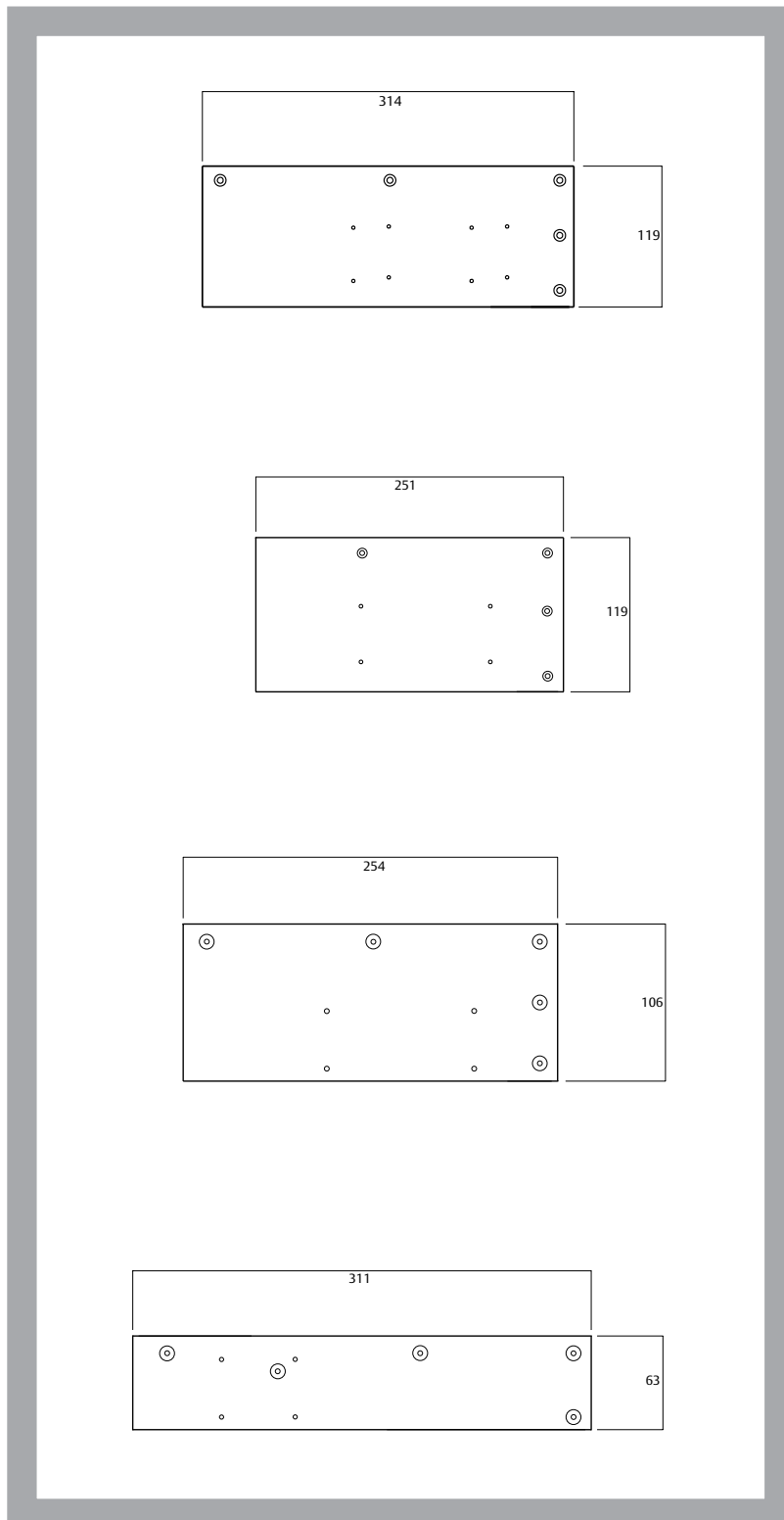



## Lockwood Electromechanical Door Control Systems

It is vital for fire doors to close in the event of fire. The fire door must close and latch automatically in order to limit the spread of fire into the other parts of the building. During daytime the normal use of a fire door may require the doors to remain open.

Lockwood fire door closing systems guarantee easy access and convenience for use in normal situations as well as maximum security in the event of fire. Lockwood fire door closing systems are composed of reliable and compatible components that enable building up a safe, individual solution for each application.

### Major Features

#### Design

Compact modern design to suit both single and double door installations.

#### Flexibility In Installation

- easy to install on narrow frames (40mm)
- one unit suits both push side or pull side

#### Door Sizes

- single door applications minimum 350mm, maximum 1250mm
- double door applications minimum 1350mm, maximum 2500mm

#### Offset To Door Stop

- pull side - maximum 18 mm
- push side - maximum 30 mm
- maximum distance between face of architrave and centre line of hinge is 90mm

#### Hold-Open Device

- easy to install with adjustable angles (90° to 130°)
- hold-open strength can be adjusted during the installation

#### Opening Angles

Maximum opening angle

- Push Side, 120°
- Pull Side, 130°

#### Electrical Specifications

24Vdv ± 15%. Low consumption:  
max.current 60mA per hold-open device

#### Co-ordinator (Double Doors)

When a pair of rebated doors are fitted with the



door closers it is essential that the doors close in their correct sequence.

- built in sequence selector holds the inactive door open independently until the active door has closed.
- guarantees the doors closing in the correct order with accurate closing times.

### FIRE RATED

The Lockwood Electro magnetic Door Control System has been successfully fire tested up to 4 hours on fire door assemblies in accordance with Australian Standard AS1905.1:1997 - Part 1: Fire resistant doorsets.

### Fire Door Closing System

**An example of the operation and main components of a fire door closing system.**

If fire doors are held open they must close at the break out of fire, so that smoke and flames can be retained and not spread throughout the building.

The smoke detector (1) reacts to smoke and activates the alarm to switch off the hold-open device of the door (2). The door closer (3) controls the door to close and latch into the shut position. (4) Add optional release button clipsal 30 MBP and mounting plate.

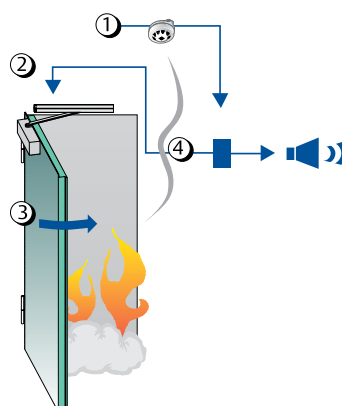

# Door Closers

## 7726 Series Door Closers

### Single Door Function

The door is held open by hold open device in the selected angle. When the power is switched off, e.g. when smoke detectors react to smoke, the door closes. Hold open angle for active door can be adjusted from 80° to 130°. Power consumption 1 x 60 mA.

#### Part Numbers

7726EMCSSS	Satin Stainless Steel
7726EMCGLD	Gold
7726EMCSIL	Silver

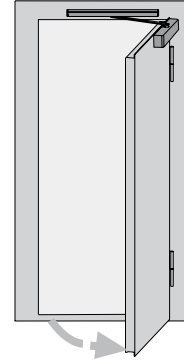

### Double Door Function

The inactive door is normally closed (1) and remains open only if someone holds it open. When the power is switched off, e.g. when smoke detectors react to smoke, the active door closes. Hold open angle for active door can be adjusted from 80° to 130°. Power consumption 1 x 60 mA.

#### Part Numbers

7726EMCDSSS	Satin Stainless Steel
7726EMCDGLD	Gold
7726EMCDSIL	Silver

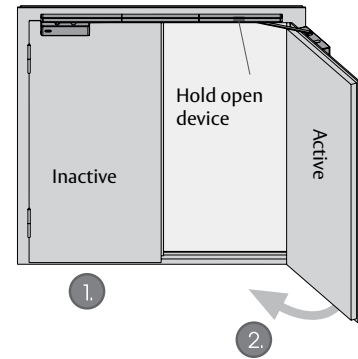

### Mechanical Door Coordinator

During the day the doors are normally closed and the active door is used as passage door. If both doors need to stay open, the active door must be opened first (1), after which the inactive door can be opened (2). The co-ordinator holds the active door in the desired angle during the time the inactive door is open. The inactive door stays open only if someone holds it or a wall magnet is used. When the inactive door is closed (3), the active door starts to close (4).

#### Part Numbers

7726COSSS	Satin Stainless Steel
7726COSIL	Silver

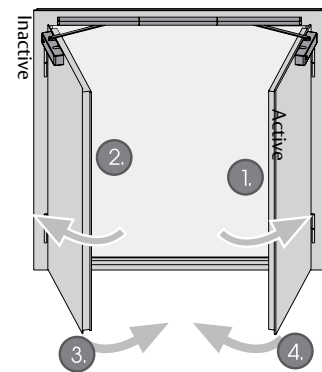

## 7726 Series Accessory Installation Examples

### Opening Side - Single Door

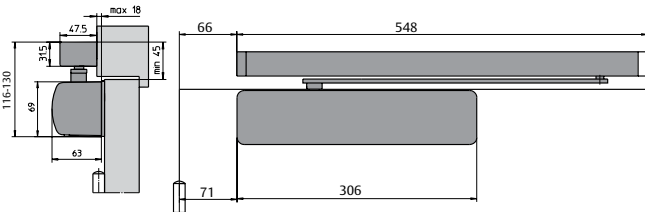

### Closing Side - Single Door

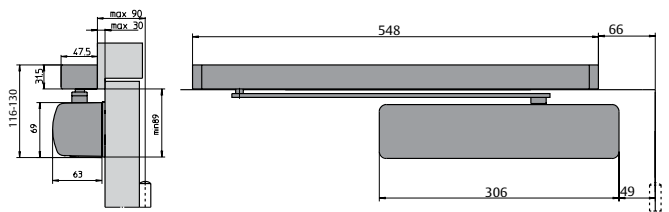

### Opening Side - Double Door

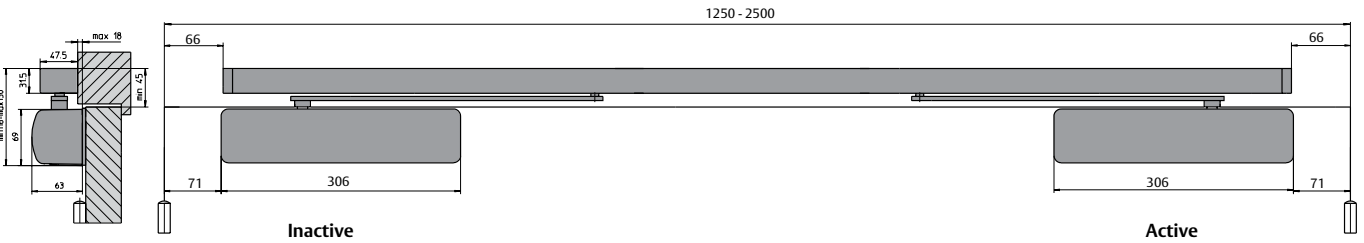

### Closing Side - Double Door



## Typical Limiting Dimensions

### Flat mounting plate 7726-103 for single doors (Double doors X 2)

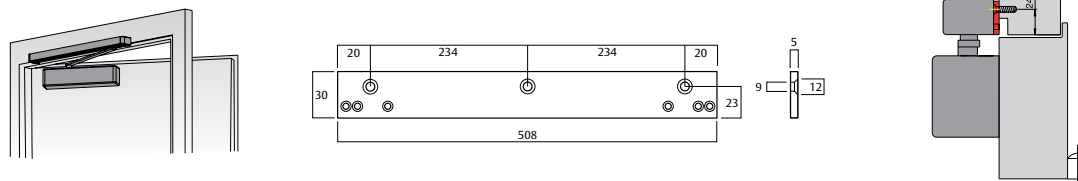

### Flat mounting plate 7726-103 for double doors (Double doors X 2)

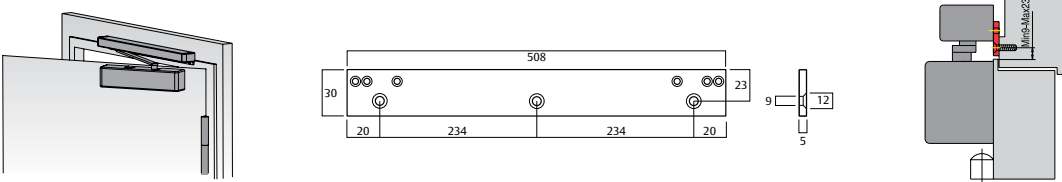

### Angle mounting plate 7726-105 for single doors (Double doors: 2 X 7726-105 plus centre piece 7726-109)

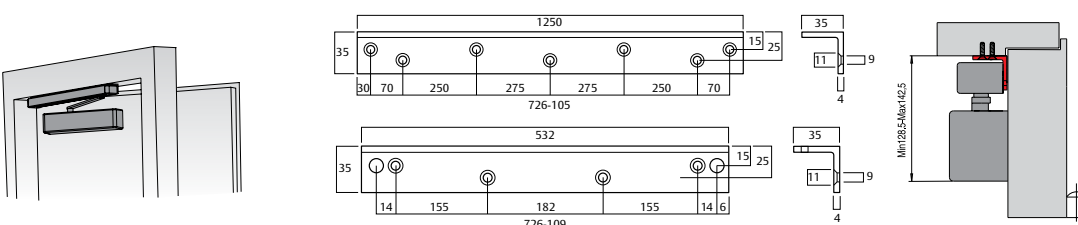



## 9024 Series Concealed In-Door Closer

The beauty of the new Lockwood 9024 concealed doorcloser is that it stays virtually invisible when the door is closed, keeping your design pure and clean just as you intended. Featuring efficient 'cam action' technology, it has an in-built power adjustment mechanism which allows you to reduce opening force whilst maximising closing force, making it perfect for almost every new door design. When it's all about aesthetics, the new Lockwood 9024 Series concealed doorcloser is the best choice.



### Major Features

- Cam action for low opening moment
- Power adjustable Size 2-4
- Cast iron body
- Fits timber doors from 45mm thickness
- Fits metal profiles with 36 x 45mm inner chamber
- Max opening angle 120°
- Two speed valves:
  - One to control Closing speed from 120° to 0°
  - Second to activate final latch from 15° to 0°
- Cushioned opening
- Overpressure relief valve
- Adjustable Hold Open from 70° to 95°
- Non handed

### FIRE RATED

Approved on fire door assemblies to 2HR, in accordance with Australian Standard AS1905.1-2005, Part 1.

### Recommended Maximum Door Size

In case of doors subject to wind or air draught select the next size up.

Min Power - 2 = 15 Nm  
Max Power - 4 = 32 Nm

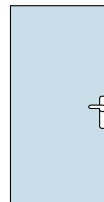

min. 750 x 2100  
max. 1100 x 2400

### Limiting Dimensions

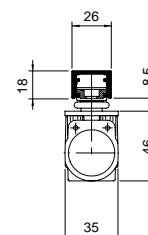
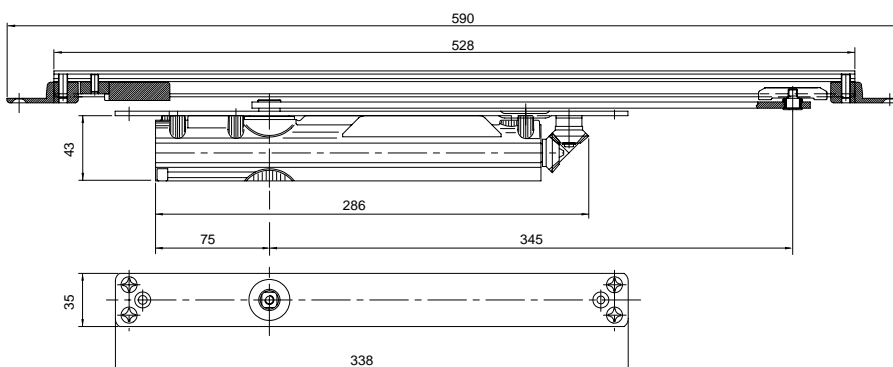

# Door Closers

## Closing Force Adjustment

Convenient Power adjustment enables the door closer to be adjusted when installed to meet site conditions.

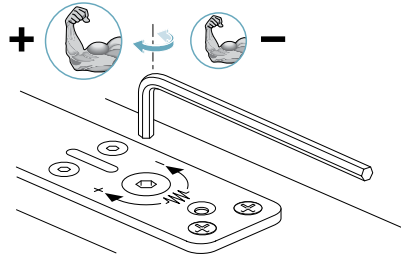
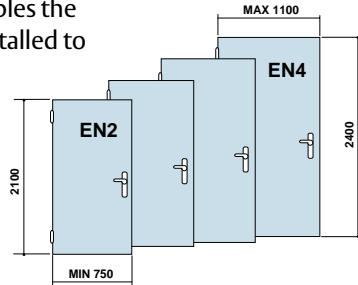

## Closing Speed Adjustment (~120° - 0°)

Can be easily adjusted after installation.

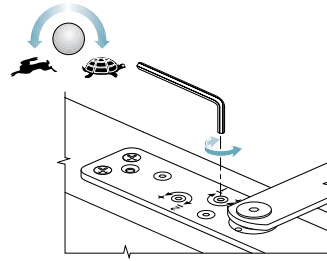
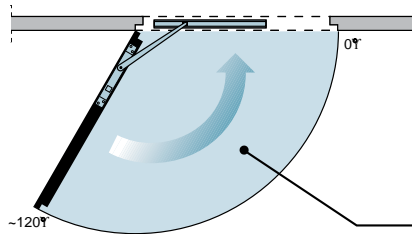

## Adjustment of Final Latch (~15° - 0°)

Ensures door will close and engage latch bolt for added security.

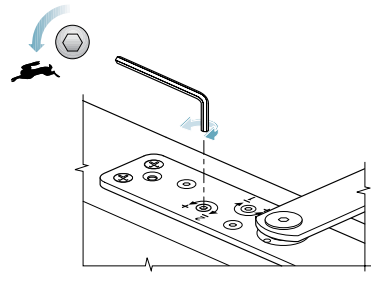
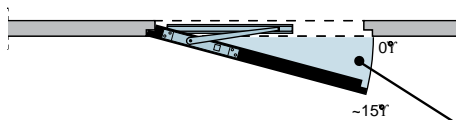

## 9024-581

Hold Open Device. Angle adjustable between 70° - 95°.

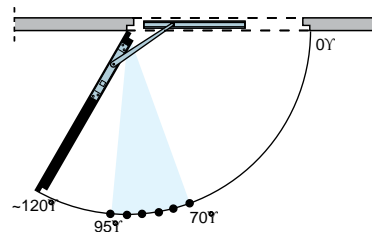
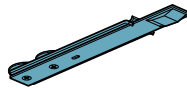
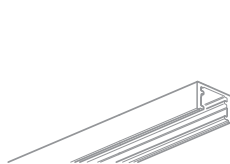

## 9024-596

Cushioned Back Stop.

Helps cushion any sudden opening of the door.

Helps protect walls from door damage.

Does not replace floor stop.

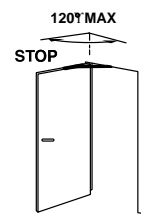
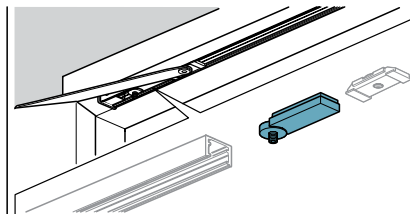
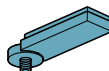

LOCK UP (1300 562 587)  
lockweb.com.au



## Preparation for Metal Doors

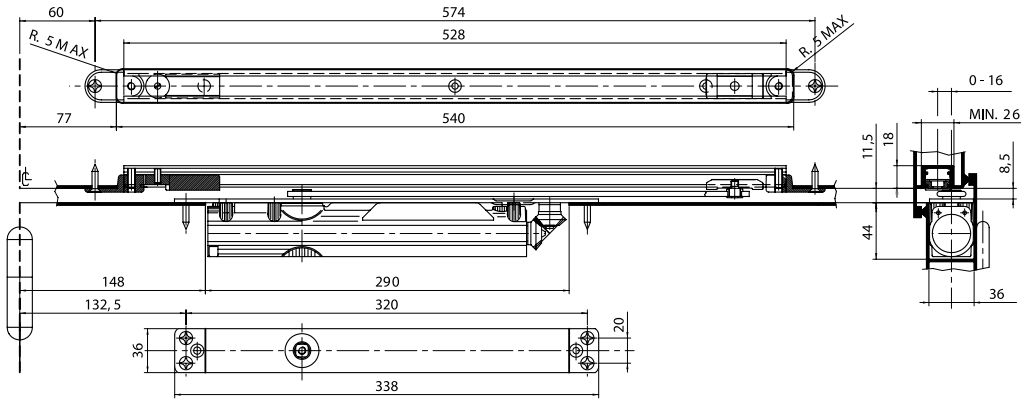

## Preparation for Timber Doors

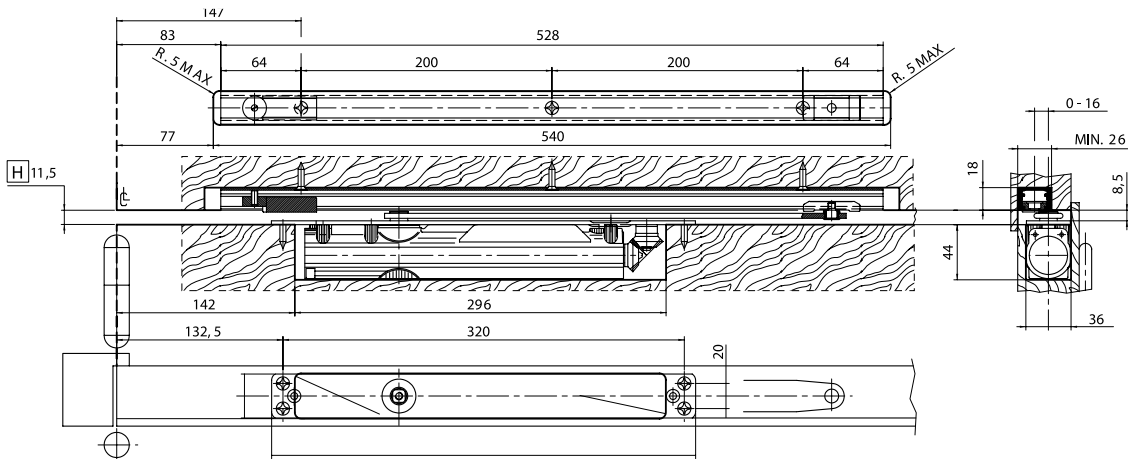

## Preparation for Timber Doors H < 11.5mm

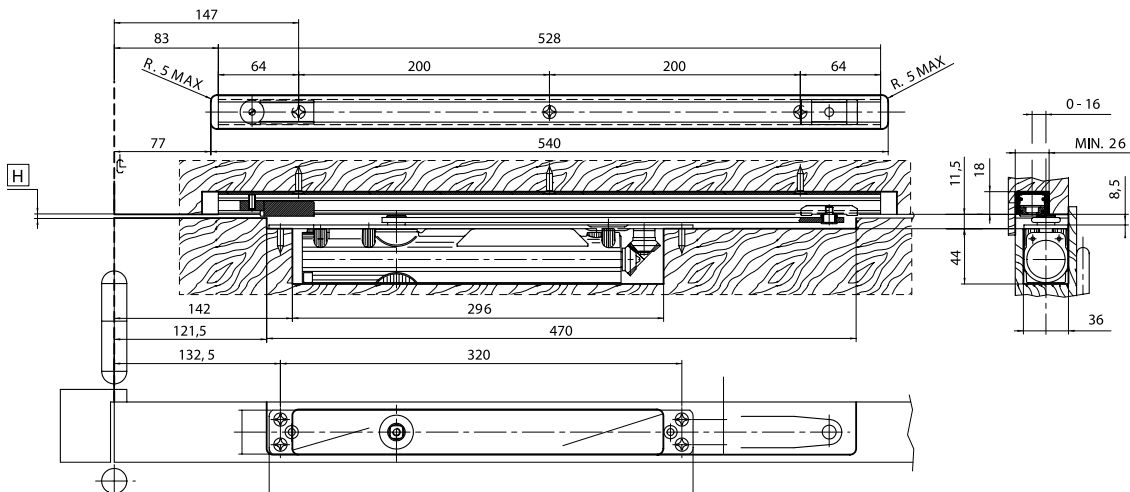

# Door Closers

## Lockwood Door Stays

### 8001C Concealed Door Stay

The Lockwood concealed door stay is the ideal choice where an uncluttered look or the clean lines of the door are required to be seen. Lockwood 8001C door stays are ideally suited for medium to light duty applications where the expense of a hydraulic door closer cannot be justified.

#### Major Features

- New and improved smooth action roller mechanism
- Noiseless friction hold-open
- Non-handed
- Mechanism tested to 500,000 cycles
- Stainless steel and anodized aluminium finishes
- Suitable for both 90° and 180° openings
- Suitable for patio, partitioning, cupboards, switchroom, FHR type doors
- Suitable for door widths from 400mm to 850mm
- Suitable for door thicknesses from 32mm



#### Limiting Dimensions

Dimensions in millimetres.

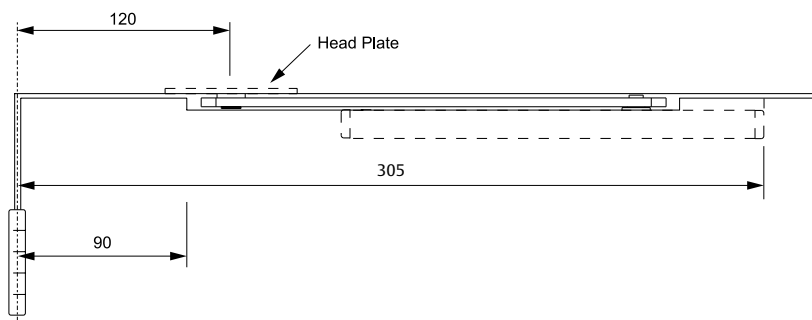

#### Single Action Opening Door

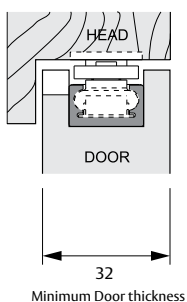

#### Double Action Opening Door

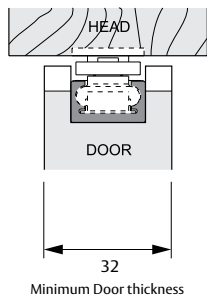

#### Finish Available

Satin Stainless Steel

SSS

Other finishes available on application.

#### Part Number

8001CSSS

## 8001S Surface Mounted Door Stay

The Lockwood surface mounted door stay provides effective door control for medium to light duty doors. These products mount to the surface of the frame and require a minimum amount of door and frame preparation. Lockwood 8001S door stays are ideally suited for medium to light duty applications where the expense of a hydraulic door closer cannot be justified.

### Major Features

- New and improved smooth action roller mechanism
- Noiseless friction hold-open
- Non-handed
- Mechanism tested to 500,000 cycles
- Stainless steel and anodized aluminium finishes
- Suitable for door leaves that are required to open or hold-open at 90°
- Suitable for patio, partitioning, cupboards switchroom, FHR type doors
- Suitable for door widths from 400mm to 850mm
- Suitable for most door thicknesses

### Limiting Dimensions

Dimensions in millimetres.

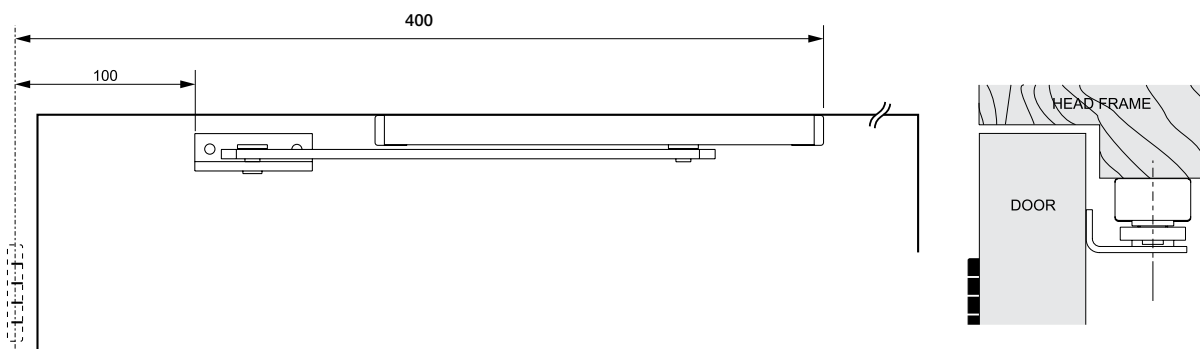

### Finish Available

Satin Stainless Steel      **SSS**  
Other finishes available on application.

### Part Numbers

8001SSSS	Door Stay Push Side
8001PSSS	Door Stay Pull Side

ASSA ABLOY is the global leader in door opening solutions, dedicated to satisfying end-user needs for security, safety and convenience



ASSA ABLOY



Lockwood is the leading brand in the Australian locking industry. With an established reputation for high quality products, this iconic brand provides a wide range of locking solutions to residential housing, commercial building and industrial application markets. Lockwood is supported by an extensive distribution and after-sales support network. Our customers include retailers, architects, trade and industrial personnel, locksmiths and security dealers.

**ASSA ABLOY**

ASSA ABLOY is the global leader in door opening solutions, dedicated to satisfying end-user needs for security, safety and convenience.

ASSA ABLOY is represented in all major regions, in both mature and emerging markets, with leading positions in Australia, Europe and North America.

As the world's leading lock group, ASSA ABLOY offers a more complete product range of door opening solutions than any other company in the market.

**Australia**  
**1300 LOCK UP (1300 562 587)**  
**lockweb.com.au**

**New Zealand**  
**Telephone +64 9415 7888**  
**assaabloy.co.nz**

ASSA ABLOY Australia Pty Limited  
235 Huntingdale Road,  
Oakleigh Victoria, 3166  
Australia

ASSA ABLOY New Zealand Ltd.  
6 Armstrong Road  
Albany, North Shore City, 0632  
New Zealand

info.au@assaabloy.com  
assaabloy.com.au

info.nz@assaabloy.com  
assaabloy.co.nz

