

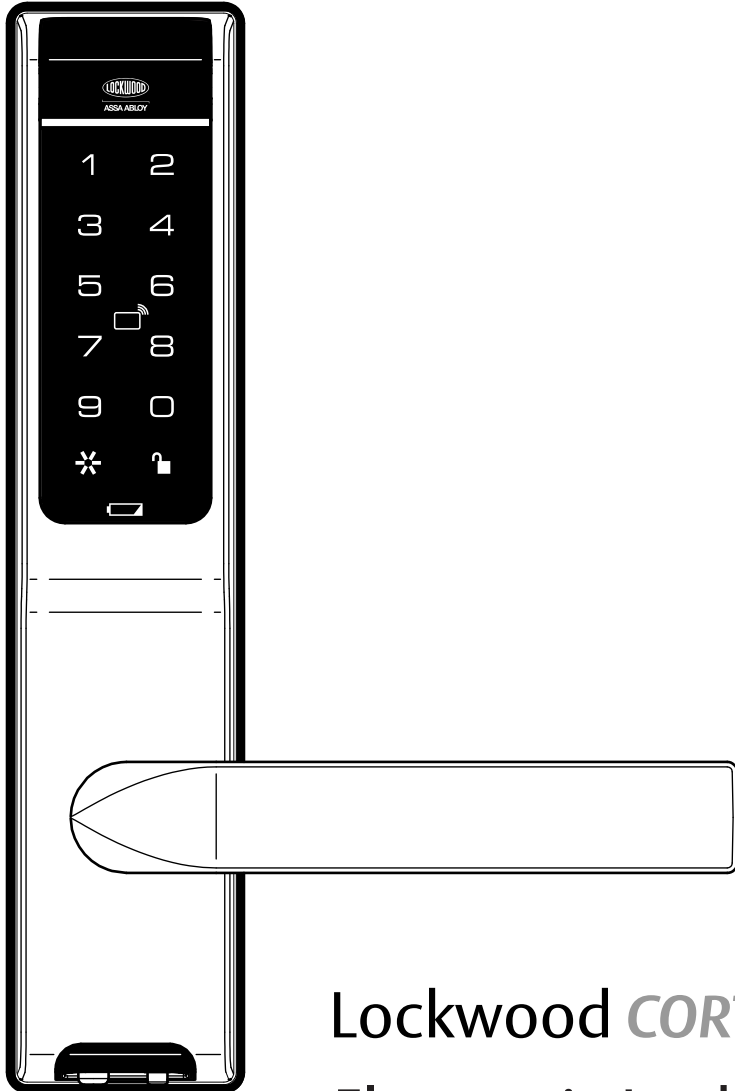

# Lockwood *CORTEX*™

## USER GUIDE



Lockwood *CORTEX*™  
Electronic Lockset



ASSA ABLOY

## Introduction

The Lockwood CORTEX™ intelligently combines the convenience of digital locking technology with a contemporary aesthetic.

Users benefit from an interactive touchscreen that makes day-to-day access effortless and convenient.

CORTEX™ features the choice of “EZ” mode or “Advanced” operations modes. Locks are shipped as a default in “EZ” mode. The desired operating mode should be determined before the completion of the lock installation, but can be changed at a later time if required.

### Mode Selection

It's important you understand the differences between EZ mode and advanced mode. Decide what functions the user needs before selecting the appropriate mode.

## Warnings

**CAUTION:** Changes or modifications to this unit not expressly approved by the party responsible for compliance could void the user's authority to operate the equipment.

**IMPORTANT:** The accuracy of the door preparation is critical for the proper functioning and security of this product. Misalignment can cause premature wear and a lessening of security. The CORTEX™ should only be serviced by a qualified technician.

**Finish Care:** This lockset is designed to provide the highest standard of product quality and performance. Care should be taken to ensure a long-lasting finish. When cleaning is required use a soft, damp cloth. Using lacquer thinner, caustic soaps, abrasive cleaners or polishes could damage the coating and result in tarnishing. Do not clean screen with any cleaning products containing bleach. Do not install the lock in close proximity to caustic vapours or where it may be subjected to extreme weather conditions.

# Contents

Introduction	2
Warnings	2
Main Features	4
Quick Guide - Keypad Programming	5
Quick Guide - Keypad Operation	6
Keypad Functions	7
Battery Replacement	7
EZ Mode Product Definitions	8
EZ Mode Functions	9
EZ Mode - Keypad Programming	10
EZ Mode - Programmable Functions	11
EZ Mode - Check Programmable Functions	12
Advanced Mode Product Definitions	13
Advanced Mode Functions	14
Advanced Mode - Master User Programming	15
Advanced Mode - Programmable Functions	16
Advanced Mode - Special User Functions	17
Emergency Power Supply	18
Troubleshooting	18
Advance Mode PIN Code Management	19

# Main Features

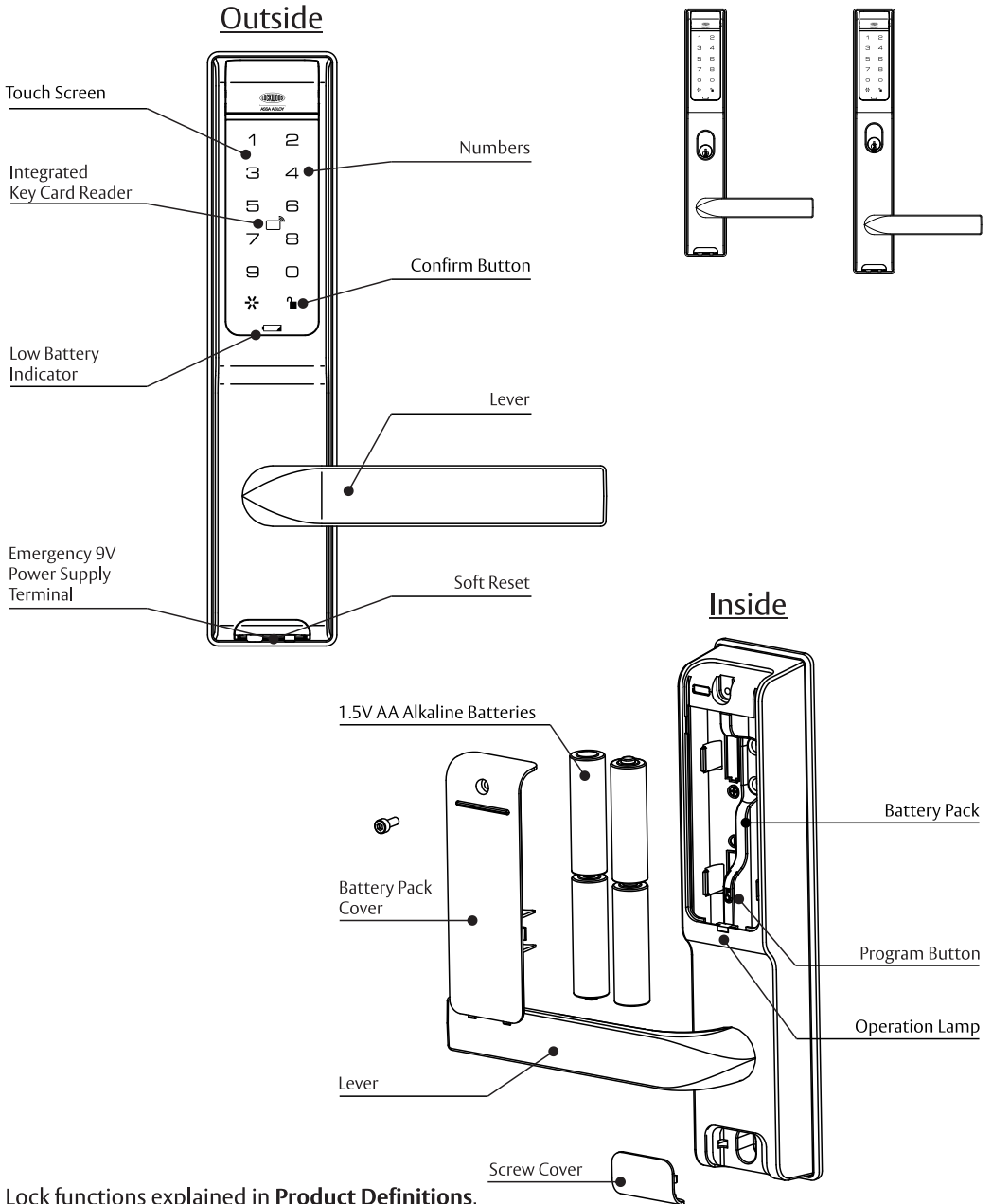

Lock functions explained in **Product Definitions**, refer page 8.

# Quick Guide - Keypad Programming

## CORTEX™ Quick Programming Guide

Note: This quick guide is for EZ Mode only, for Advanced Mode please refer to page 13.

### To Program Keypad with User Pin Code

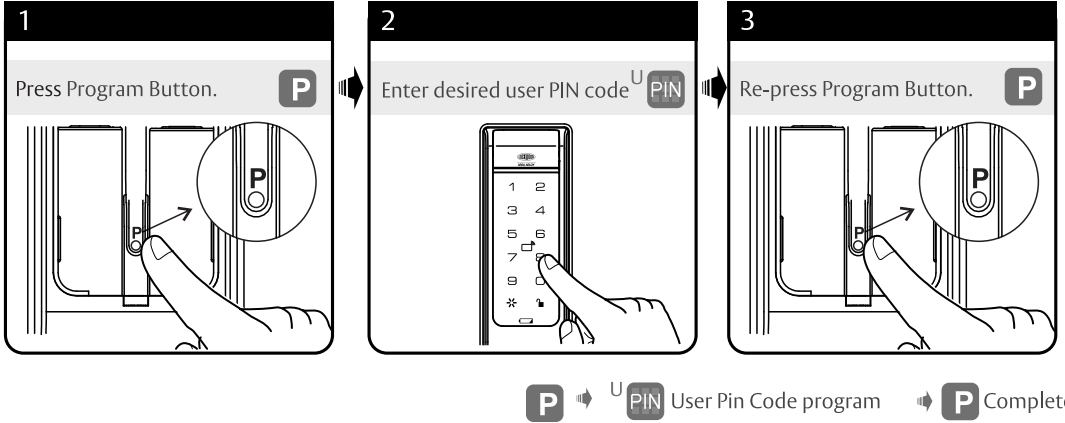

### To Program Keypad with Key Card

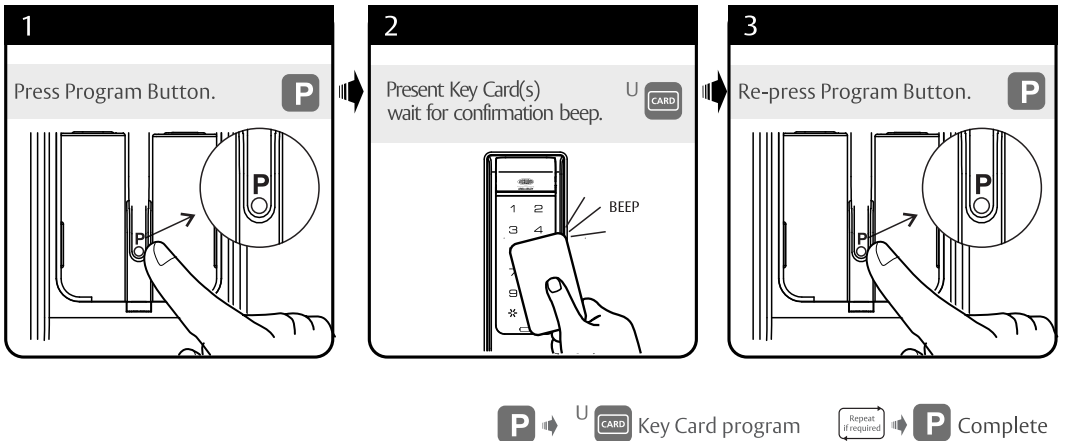

Note: In EZ mode; you can enter a 4-10 digit PIN code and up to 40 Key Cards can be registered

Always ensure you test the User PIN code and Key Card with the door open to ensure the lock code or Key Card is working correctly.

# Quick Guide - Keypad Operation

## CORTEX™ Quick User Guide

Note: This quick guide is for EZ Mode only, for Advanced Mode please refer to page 13.

### To Open Door with User PIN Code

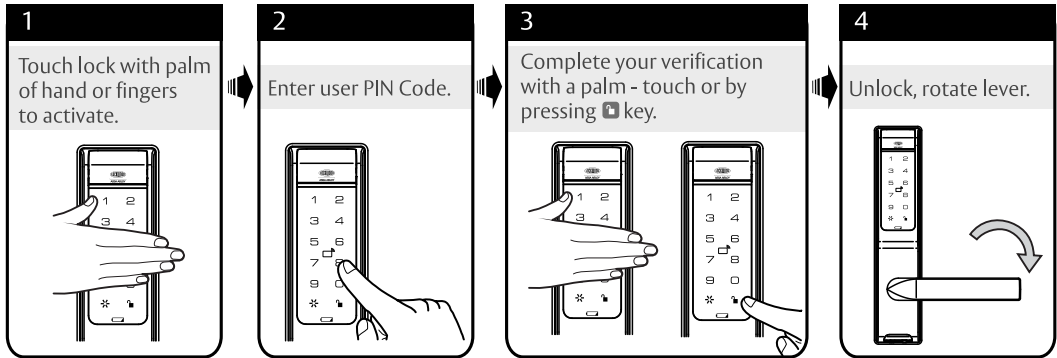

### To Open Door with Key Card

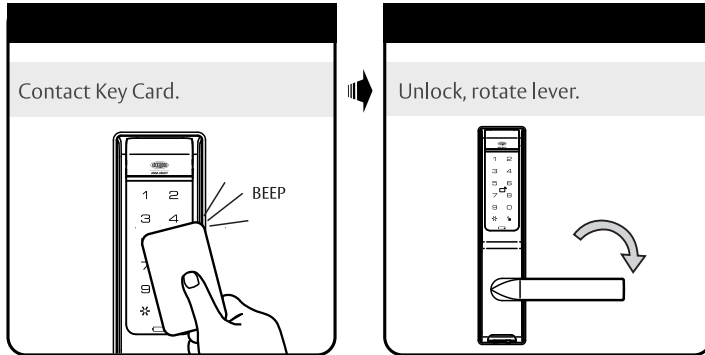

### Quick Notes

- Programming a new key card will not affect the user PIN code.
- Programming a new user PIN code will not affect the key card.
- Deleting user Pin – This can be accomplished by reprogramming a new pin and the old will be overridden.
- Deleting key card – This can be accomplished by reprogramming the key cards at hand, any key cards not present will be deleted.
- Note: If you choose to only ever use a pin code for entry it could be handy to enroll a key card as a backup.

# Keypad Functions

## Smart Pad

### Low Battery Warning

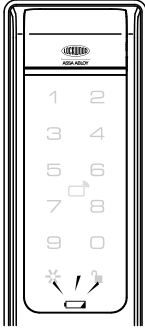

### Wrong Code Entry Limit Warning

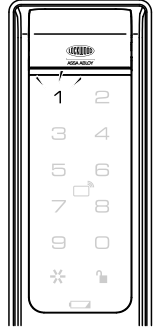
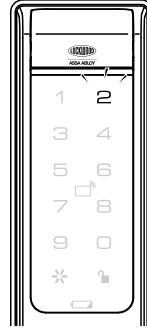

# Battery Replacement

To install batteries, first remove Battery Pack Cover by unscrewing the Battery Pack Screw with the tool supplied, slide the cover up to open the Battery Pack. Insert 4 good quality alkaline AA batteries into the Battery pack as shown. Re-insert cover and re-fasten battery pack screw.

Batteries must be new good quality alkaline and not be mixed between new and old.

Caution: Dispose of them responsibly and do not throw batteries in fire.

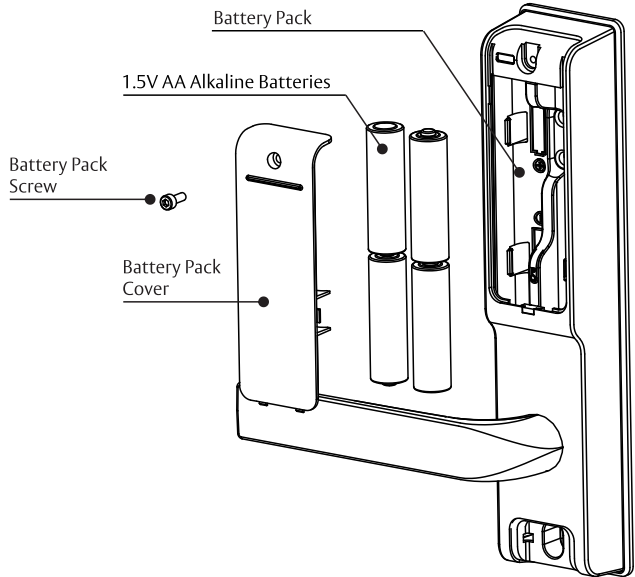

# EZ Mode Programmable Functions and features

## EZ MODE

**EZ mode:** This mode is used if you want one simple PIN code or several key cards programmed into the lock. Up to 40 cards can be programmed into the lock at a time however these key cards can't be individually added and removed.

**Programming cards or PIN:** In EZ mode the "P" button is used to enrol a new PIN or key cards. A valid PIN entry will unlock the door for 5 seconds.

**Key cards:** Key cards are handy for children or the elderly that may forget or cannot easily use the pin code function. Key cards are held in front of the lock for 2 seconds; the lock should then remain unlocked for 5 seconds. Key cards can also be used as backup credentials.

**Your user Pin code:** Is also used to program the following functions and features into the lock:

**Program time & date:** You have the ability to programme the time\* and date into the lock, this will allow you to set the visitor code to be valid for as long as you want.

**Visitor code:** You can program a single visitor code and allow that code access between a certain date period. This is ideal if you have a contractor or visitor that may need access for several days. Time and date must be entered for this function to work.

**Program Passage Mode:** If passage mode is enabled the lock will remain unlocked until again disabled.

**Battery Check:** You have the ability to check the battery level at any time, during the checking process a field of led's on the keypad will light up according to the strength of the batteries. (refer page 11)

**Volume on/off:** You have the ability to disable or enable the audible tones in the EZ mode.

**Cryptic Code function:** Prevents others from seeing your PIN during access. This allows any random digit to be entered before or after your real PIN to confuse onlookers.

**Soft reset:** Located in between the emergency 9v power socket. Insert a small pin (paperclip size) this will reboot or refresh the internal software. This is only used if your lock malfunctions. NOTE: this will not reset your pin, cards, time and date or any settings.

**Low battery:** You can check the status of your battery at any time. However if your battery need to be replaced the low battery warning will prompt you to do so. Please replace the battery with good alkaline batteries when you see this warning.

**Program Button:** Located on the internal battery housing, the program button is used for changing the user PIN or enrolling new Key Cards (Only used in EZ Mode).

\*Daylight saving time changes need to be updated manually when they occur or during battery changes.



# EZ Mode Functions

## Factory Defaults



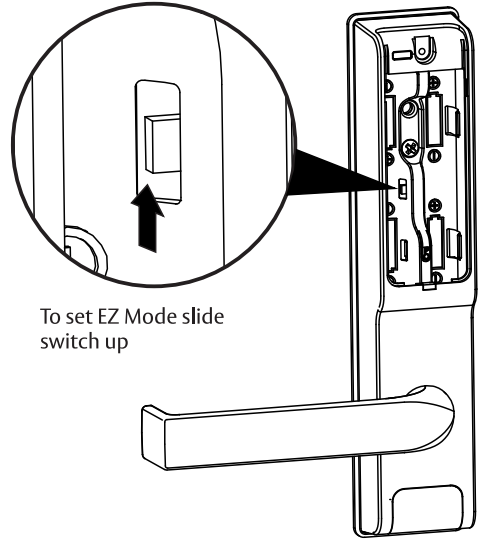







Settings	Factory Defaults
Default Mode	EZ Mode
User PIN Code	1234567890
Passage	Disable
Visitor Code	Non
Volume	On
Relock time	5 sec. *
Wrong code entry limit	5 times *
Shut down time	180 sec. *



- EZ mode allows for a single User PIN Code to be assigned.
  - Up to 40 Key Cards can be programmed into the CORTEX in this mode.
  - With the use of the User PIN Code a number of basic functions outline on page 11 can be accessed.
  - A User PIN Code between 4 to 10 digits can be entered.
  - For programming new User PIN Code in EZ mode refer to the next page.
- \* These values cannot be changed.

## Programming Icons - EZ Mode

### EZ Mode

	Touch the screen with palm of hand or fingers to activate pad		Enter User code. (4-10 Digits) Factory default: 1234567890
	Push the indicated Number		Enter Visitor PIN. (4-10 Digits)
	Press the * key on the touchscreen to enter Menu mode.		Enter user key card(s) Add up to 40 cards
	Press the  key on the touchscreen to unlock or accept PIN code		Set the Time and Date
	Program button when programming User PIN or Keycard		Repeat operation using settings indicated

# PIN and Key Card programming – EZ Mode

## To Program Keypad with Pin code

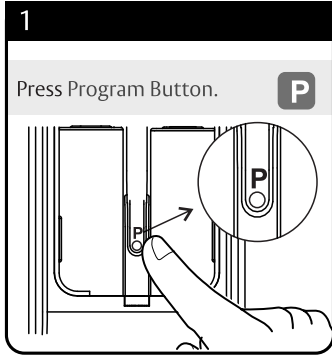

After removing the battery cover press the Program button, you will hear a confirmation tone.

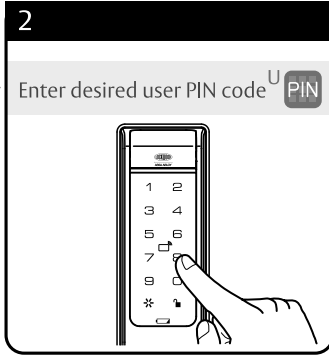

You now have 20 seconds to enter your 4-10 digit user PIN code.

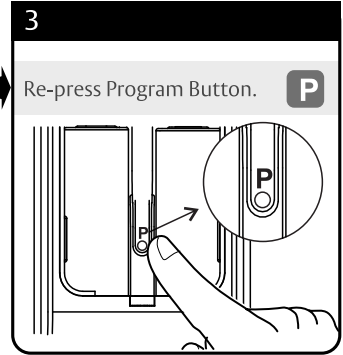

Re-press the Program button, you will hear another confirmation tone. Now watch the keypad and your code will briefly appear.

**P** → **U PIN** User PIN code program → **P** Complete

## To Program Keypad with Key Card

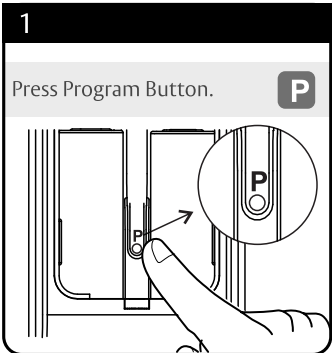

After removing the battery cover press the Program button, you will hear a confirmation tone.

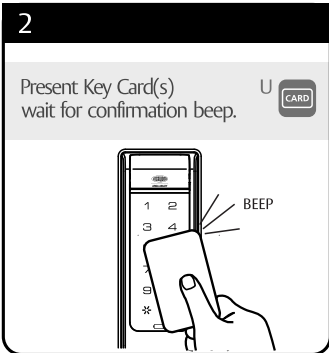

You now have 20 seconds to present card to lock, wait for beep and if you require additional cards repeat.(up to 40 Cards)

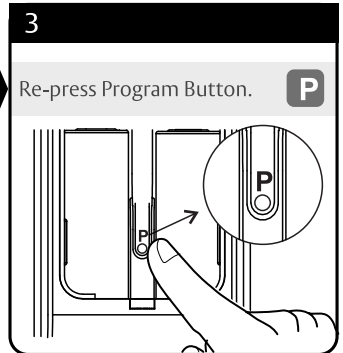

Re-press the Program button, you will hear another confirmation tone

**P** → **U CARD** Key Card program → **Repeat if required** → **P** Complete

# Programmable functions – EZ Mode

## User PIN Code / Key Card Program

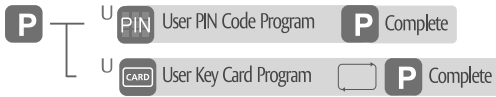

## EZ Mode Programmable functions

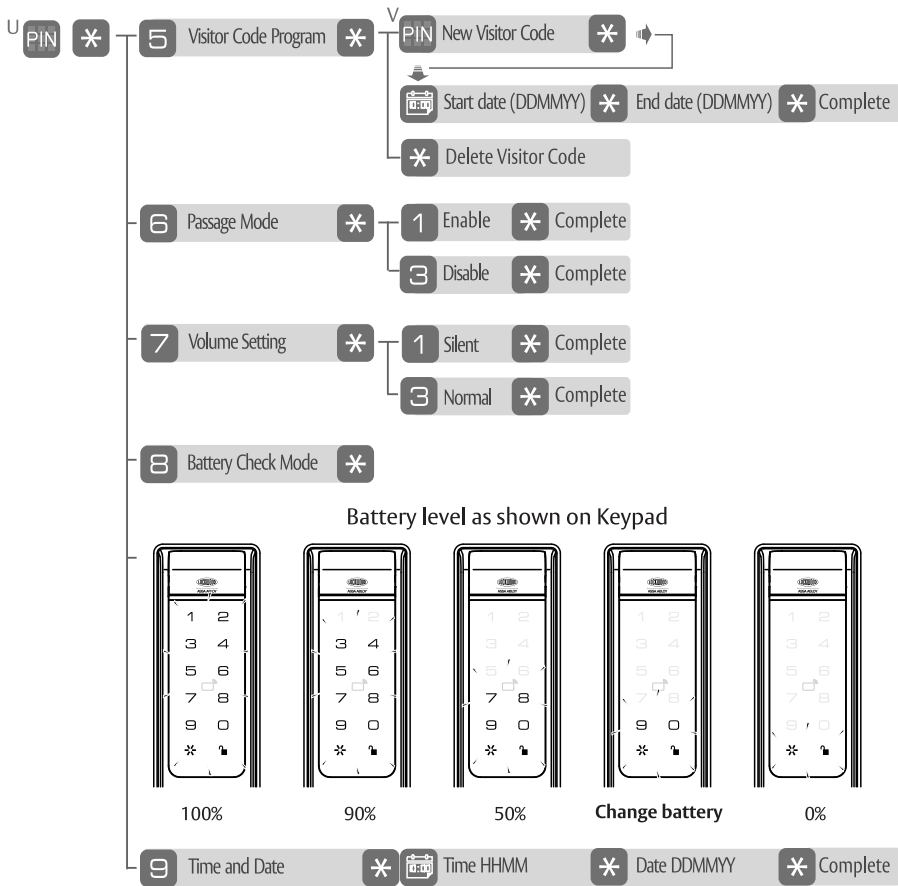

Battery level as shown on Keypad

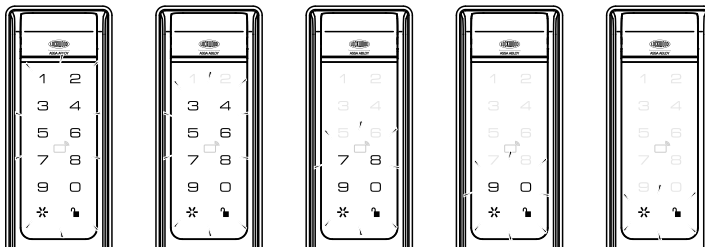

NOTE : Time should be entered in 24hour format. [1623] = 4:23 PM  
 NOTE : Date Format [240316] = 24 March 2016

# Check programmable functions - EZ Mode

You also have the ability to check the programmed values that have been programmed into the lock.

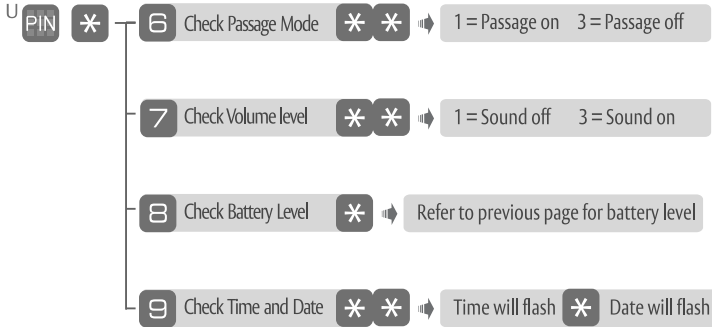

# Advanced Mode Programmable Functions and features

**ADVANCED MODE** has basic access control features that allows multiple users to be added and removed by the “Master”

**Master Code** - Is used to program the following functions and features into the lock.

**PIN Code:** Up to 20 PIN codes can be entered, these PIN codes can be individually added or removed. Ideal for scenarios where the master can add and remove PIN codes as and when needed

**Key Cards:** 40 Key cards can be added and removed individually. Ideal for scenarios where the master can add and remove cards as and when needed. Key cards are held in front of the lock; the lock should remain unlocked for 5 seconds. Key cards are handy for children or the elderly that may forget or cannot easily use the pin code function. Key cards can also be used as backup credentials.

## **Special Users:**

**One Time Pin** – This allows you to set a pin that can only be used once and will automatically expire once used

**Disabled access** – Gives users extra time to open the door. Enter this PIN or card and the door will remain unlocked for 15 seconds.

**Dual credential** - For higher security a dual credential will allow a user to have a PIN and a card to gain access. This functions as follows; Program the PIN in location 20 and program the Card to location 60. (as shown on Page 17) to operate; Present the Card first, within 15 seconds enter the PIN. The lock will now unlock.

**Timed Access** – Allows you to keep the lock unlocked for certain part of the day or night. Program a start and end date then program a start and end time. The lock will remain open during this time and date.

**Programming button:** The programming button does not function in advanced mode.

**Program time & date:** You have the ability to programme the time\* and date into the lock, this will allow you to set the visitor code to be valid for as long as you want, or use the timed access function.

**Visitor code:** You can program a single visitor code and allow that code access between a certain date period. This is ideal if you have a contractor or visitor that may need access for several days.

**Program Passage Mode:** If passage mode is enabled the lock will remain unlocked until again disabled.

**Battery Check:** You have the ability to check the battery level at any time, during the checking process a field of led's on the keypad will light up according to the strength of the batteries.

**Volume on/off:** You have the ability to disable or enable the audible tones in the Advanced mode.

**Cryptic Code function:** Prevents others from seeing your PIN during access. This allows any random digit to be entered before or after your real PIN to confuse onlookers.

**Soft reset:** Located in between the emergency 9v power socket. Insert a small pin (paperclip size) this will reboot or refresh the internal software. This is only used if your lock malfunctions. NOTE: this will not reset your pin, cards, time and date or any settings.

**Low battery:** You can check the status of your battery at any time. However if your battery need to be replaced the low battery warning will prompt you to do so. Please replace the battery with good alkaline batteries when you see this warning.

\*Daylight time changes need to be updated manually when they occur.

# Advanced Mode Functions

## Factory Defaults

Settings	Factory Defaults
Master Code	123456
Passage	Disable
Visitor Code	Non
Volume	On
Relock time	5 sec. *
Wrong code entry limit	5 times *
Shut down time	180 sec. *

\* - These values cannot be changed.

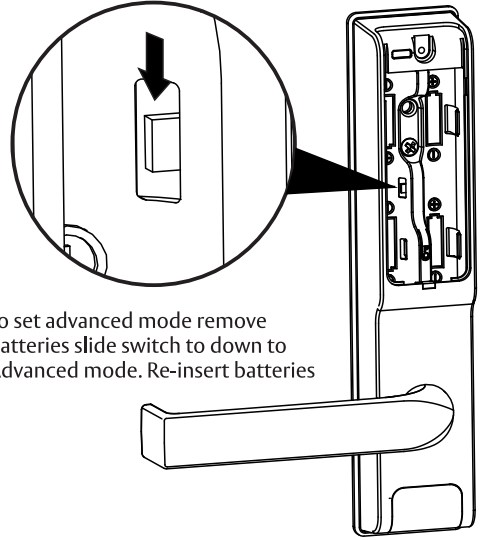

To set advanced mode remove batteries slide switch to down to Advanced mode. Re-insert batteries

## Programming Icons – Advanced Mode

	Touch the screen with palm of hand or fingers to activate pad	M	Master PIN code (4-10 digits) Factory default 123456
1 ~	Push the indicated Number	U	Enter User code. (4-10 Digits) Factory default: 1234567890
	Press the * key on the touchscreen to enter Menu mode.	V	Enter Visitor PIN. (4-10 Digits)
	Press the  key on the touchscreen to unlock or accept PIN code	U	Enter user key card(s) Add up to 40 cards
	Dual Credential. Card and PIN	1	One time PIN
	Set the Time		Set the Date
	Timed open function		Repeat operation using settings indicated
	User Serial Number (01-20 : User PIN codes) (21-60 : User Card)		

# Master User Programming – Advanced Mode

Unlike EZ mode all PIN codes and Key cards are programmed with a MASTER code. The Master code allows access add and delete any user and any function. The master code also unlocks the door.

## Register / Change Master Code

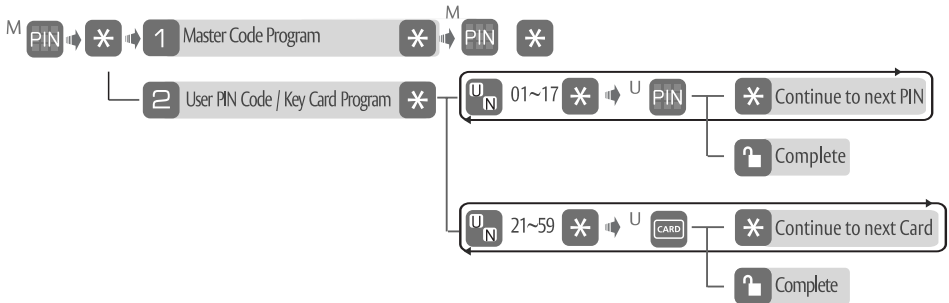
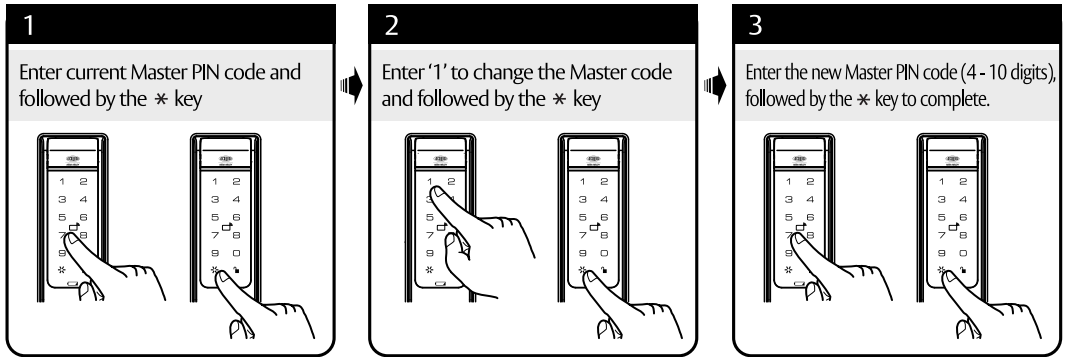

NOTE: Advanced mode allows for up to 20 Pin Codes and 40 Key Cards to be assigned. User Pin Codes and Key Cards can only be added or removed once the Master code has been entered.

# Programmable functions – Advanced Mode

## Advanced Mode Programmable functions

There are many functions like time and date that need to be programmed into the lock, refer to the following programming guide and steps for the corresponding functions.

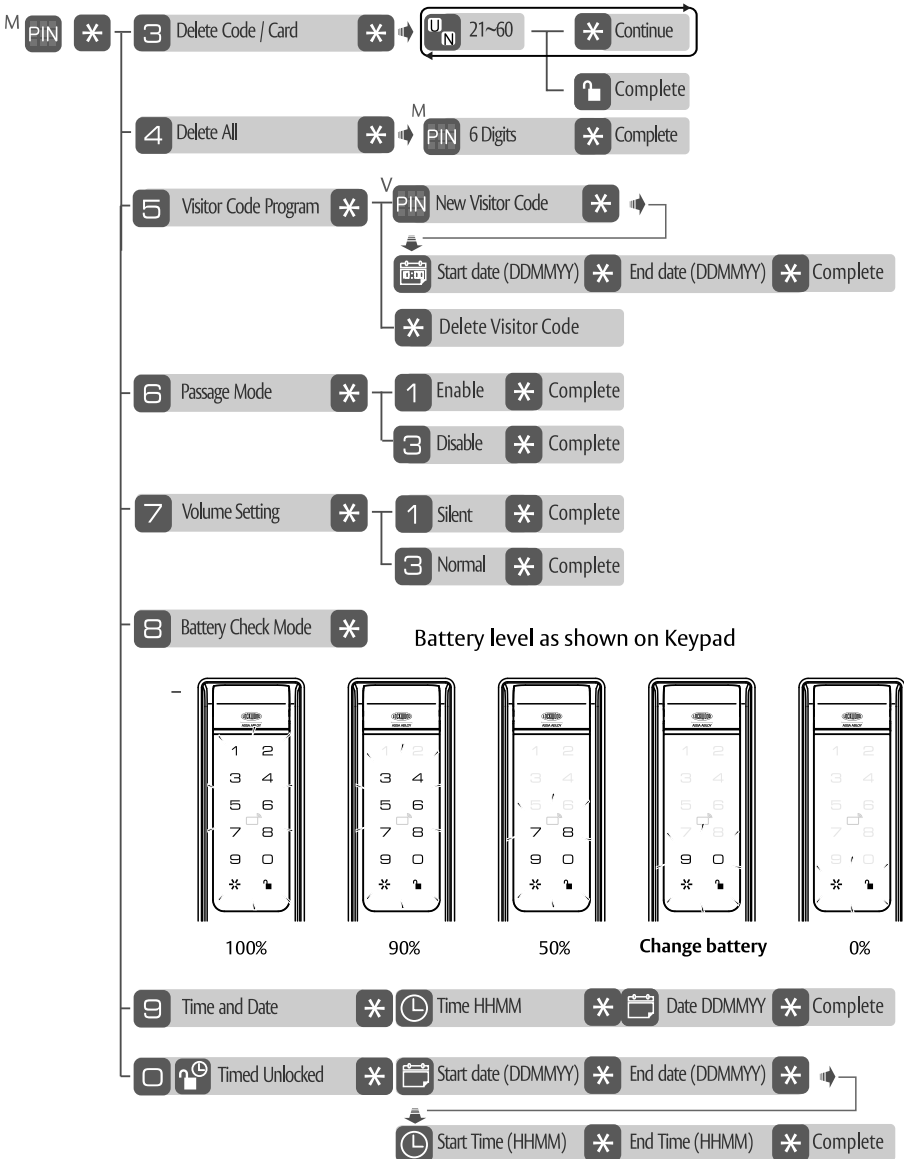

NOTE : Time should be entered in 24hour format. [1623] = 4:23 PM

NOTE : Date Format [240316] = 24 March 2016



# Check programmable functions – Advanced mode

You also have the ability to check the programmed values that have been programmed into the lock.

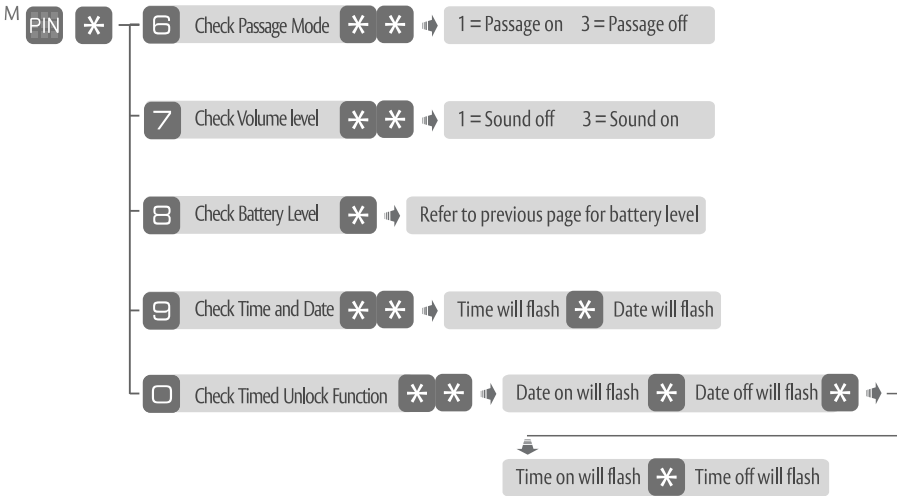

# Special Users – Advanced Mode

Extended User – User that requires extra-long time to gain access (door will remain open for 15 seconds).

M PIN \* 2 User PIN Code / Key Card Program \* 18 \* U PIN \*

M PIN \* 2 User PIN Code / Key Card Program \* 59 \* U CARD \*

One time Pin – This pin can only be used once and then automatically expire.

M PIN \* 2 User PIN Code / Key Card Program \* 1 PIN 19 \* U PIN \*

Dual Credential – If you like to set Dual access so you need a Card and PIN to gain access.

M PIN \* 2 User PIN Code / Key Card Program \* 20 \* U PIN \*

+

M PIN \* 2 User PIN Code / Key Card Program \* 60 \* U CARD \*



# Emergency Power Supply

9V battery connections are located under the front of the outside escutcheon. In the case that the 4 AA alkaline batteries are completely discharged, a 9V battery can be used to supply power to the lock. While connecting the 9V battery, the lock can be operated as normal, thus granting access so the 4 AA alkaline batteries can be replaced. Discharged batteries should be replaced right away.

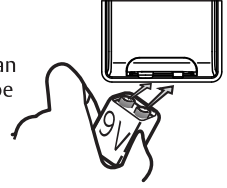

## Troubleshooting

Symptom	Suggested Action
Lock does not respond – door is open and accessible.	<ul style="list-style-type: none"> <li>The touchscreen will become active when pressed with the palm or fingers in at least 3 areas simultaneously.                             <ul style="list-style-type: none"> <li>- Use a larger area of the palm or fingers and verify contact with at least 3 areas (page 6).</li> </ul> </li> <li>If touchscreen numbers are visible, check to see if they respond when pressed.</li> <li>Check batteries are installed and oriented correctly in the battery case.</li> <li>Check batteries are in good condition (page 11); replace batteries if discharged (page 7).</li> <li>Check to see if touchscreen cable is properly connected and not pinched.</li> <li>Push Soft Reset until confirmation sound is heard.</li> </ul>
Lock does not respond – door is locked and inaccessible.	<ul style="list-style-type: none"> <li>Batteries may be completely discharged.                             <ul style="list-style-type: none"> <li>- Connect a 9-volt battery to the emergency power supply terminal which is located on the outside escutcheon, under the lever. With the 9-volt battery connected, palm the touchscreen, enter user PIN code, and palm touchscreen again (page 6). Replace batteries (page 7).</li> </ul> </li> </ul>
The unit is on for a while, and then shows no reaction. Lights dim.	<ul style="list-style-type: none"> <li>The batteries do not have enough power. Replace the batteries.</li> </ul>
Unit chimes to indicate code acceptance, but the door will not open.	<ul style="list-style-type: none"> <li>Check to see if there is another locking device on the door (i.e. deadbolt).</li> <li>Check the door gaps for any foreign objects between door and frame.</li> </ul>
Unit operates to allow access, but will not automatically re-lock.	<ul style="list-style-type: none"> <li>Check to see if Passage Mode is enabled.                             <ul style="list-style-type: none"> <li>- Disable Passage Mode to lock the door (page 11).</li> </ul> </li> <li>If low battery indicator is lit (page 7), change batteries.</li> </ul>
User PIN codes will not register.	<ul style="list-style-type: none"> <li>User PIN codes must consist of 4 to 10 digits to register.</li> <li>In Advanced mode the same PIN code cannot be used for multiple users.</li> <li>In EZ Mode, User PIN codes must be entered within 20 seconds (while the touchscreen is active) or the process will have to be restarted.</li> <li>In EZ Mode, the user PIN code can only be registered using the Program Button.</li> <li>The star (*) can not be used as part of the user PIN code.</li> <li>Master Code and User PIN Code cannot be the same.</li> </ul>
The unit operates, but it makes no sound.	<ul style="list-style-type: none"> <li>Check to see if Silent Mode is enabled (page 11 &amp; 16).</li> </ul>
The unit shows “Low Battery”	<ul style="list-style-type: none"> <li>This is the indication alerting that it is time to replace the batteries. Replace all four (4) batteries with new AA Alkaline batteries (page 7).</li> <li>Check batteries are installed and oriented correctly in the battery case.</li> <li>Check batteries are in good condition (page 11).</li> </ul>
Incorrect programming	<ul style="list-style-type: none"> <li>Reset to Factory Mode by switching the EZ mode and Advanced mode switch.</li> </ul>
Mechanical operation not working correctly	<ul style="list-style-type: none"> <li>Check alignment of lockset installation and spindle hub position and engagement.</li> </ul>

# Advance Mode PIN Code Management

	User Name		PIN Number
MASTER			
User 1			
User 2			
User 3			
User 4			
User 5			
User 6			
User 7			
User 8			
User 9			
User 10			
User 11			
User 12			
User 13			
User 14			
User 15			
User 16			
User 17			
User 18	Extended User		
User 19	One Time PIN		
User 20	Dual Credential		



ASSA ABLOY

ASSA ABLOY is the global leader in door opening solutions, dedicated to satisfying end-user needs for security, safety and convenience



Lockwood is the leading brand in the Australian locking industry. With an established reputation for high quality products, this iconic brand provides a wide range of locking solutions to residential housing, commercial building and industrial application markets. Lockwood is supported by an extensive distribution and after-sales support network. Their customers include retailers, architects, trade and industrial personnel, locksmiths and security dealers.

**ASSA ABLOY**

ASSA ABLOY is the global leader in door opening solutions, dedicated to satisfying end-user needs for security, safety and convenience.

ASSA ABLOY is represented in all major regions, in both mature and emerging markets, with leading positions in Australia, Europe and North America.

As the world's leading lock group, ASSA ABLOY offers a more complete product range of door opening solutions than any other company on the market.

**1300 LOCK UP (1300 562 587)**  
**lockweb.com.au**

Part No. EDX-221 Iss. C

